

user manual

Connected Total Eclipse Controller

(This page was intentionally left blank.)

index

1.00	overview	page
1.01	System Components	7
1.02	Features	7
1.03	Ordering Connected TE Controllers and Options	9
1.04	Formula Editor	9
1.05	Operation	10
1.06	System Diagram (Manual Update Installation)	10
1.07	System Diagram (Real-time Steaming)	10
1.08	Modes of Operation	11
1.09	Standard Mode (default)	11
1.10	Pump Mapping Mode	11
2.00	feature and options	
2.01	Auto Formula Select (AFS)	12
2.02	Count Pump	12
2.03	Flush Operation (for a Flush-compatible PI ONLY)	12
2.04	Non-Flush Operation	12
2.05	Formula	12
2.06	Formula Rules	13
2.07	Trigger Spacing and Product Queue	13
2.08	Trigger Signal Filter Time	13
2.09	8-Pump Interface	13
2.10	Acronyms and Abbreviations	14
3.00	installation	
3.01	Machine Interface Installation	15
3.02	Signal Wire Installation	15
3.03	Supply Trigger Wiring	16
3.04	Trigger Signal Wiring Notes	16
3.05	Cellular Gateway Installation	16
3.06	Connected Total Eclipse Controller Mounting	18
4.00	initial controller setup	
4.01	Set Operating Language	19
4.02	Changing Operating Language After First Power Up	19
4.03	Setting Date, Time and Time Zone	20
4.04	Setting Date, Time and Time Zone After First Power Up	21
4.05	Gateway Communication	22

index

5.00 controls

5.01 Overview	22
5.02 Menu Navigation	22

6.00 operator menus

6.01 Keys and Menu Symbols	23
6.02 Home Screen	24
6.03 Formula Quick-Select	24
6.04 Main Menu	25
6.05 Operator Menu Tree – All Menus	26
6.06 Operator Main Menu	27
6.07 Emergency Product Stop	27
6.08 Change Load Size / Weight	27
6.09 User Prime Products (if enabled)	27
6.10 User Manual Flush (if enabled)	28
6.11 View Load Count	28
6.12 About Auto Formula Select (AFS) Operation	28

7.00 installer menus

7.01 Overview (Service and Settings using Controller Keypad)	29
7.02 Key Functions	29
7.03 Password Access to Installer Menus	29
7.04 Minimum Programming Required (Standard and Relay Operating Modes)	29
7.05 Installer Menu Tree – Top Level Menus	30

8.00 installer service menus

8.01 Service Products	31
8.02 Prime	31
8.03 Calibration	31
8.04 Time Calibration	32
8.05 Volume Calibration	32
8.06 Manual Calibration	32
8.07 Name Products (optional)	33
8.08 Enter Product Costs (optional)	33
8.09 Date Tube Changed (optional)	33
8.10 Tube Alarm (optional)	34
8.11 View Load Weight	34
8.12 View Amount Dispensed	34
8.13 Clear Data Log	35

index

9.00 initial system setup menus

9.01 Edit Installer Password	36
9.02 Set Operation Mode	36
9.03 Set Operation Mode to Standard	36
9.04 Set Operation Mode to Pump Mapping	36
Set Wash Step (Add Products to a Wash Step)	37
9.05 Edit Address	37
9.06 Edit Account Name (optional)	38
9.07 Edit Machine Name (optional)	38
9.08 Edit Company Name (optional)	38
9.09 Select Pump Interface	38
9.10 Set Flush Time (Enable Flush Operation)	39
9.11 Set Signal Filter Time	39
9.12 Set [AFS] Auto-Formula Select Trigger	40
9.13 Set User Prime	40
9.14 Set LCD Contrast	40
9.15 Set Date & Time	41
9.16 Set Time Zone	41
9.17 Clear Settings to Factory Defaults	41
9.18 View Software ID	41

10.00 programming

10.01 Formula Rules	42
10.02 Program Formulas Menu	43
10.03 Product Settings	43
10.04 Set Default Weight	44
10.05 Set Count Pump	44
10.06 Set End Time Offset (optional)	44
10.07 Edit Name (optional)	45
10.08 Clear Formula	45

11.00 data transfer and units of measure

11.01 Using Formula Editor to Write a New .CTE Setup File	46
11.02 Converting a .SUP File (Legacy TE) to a .CTE File (Connected TE)	48
11.03 Read Setup	49
11.04 Write Setup	49
11.05 Write Activity Log	50
11.06 Write Records	50
11.07 Set Units of Measure	51

12.00	formula worksheet	52
13.00	transfer setup file (to USB flash drive)	
13.01	Transferring a Formula Editor Setup File	53
13.02	Access to Data Transfer Menu	53
13.03	Additional Data Transfer Information	53
14.00	reporting through Hydro Connect	
14.01	Logging in to Hydro Connect	54
14.02	Basic Navigation	54
14.03	Real-time Dashboard for Washer Extractors	55
	Washer Real-Time Production	56
	Washer Displays	56
14.04	Historical Reports for Washer Extractors	57
14.05	Historical Reports - Monthly and Date Range	58
	Alarm Summary	58
	Washer Production	59
	Chemical Usage	60
	Cost Summary	61
	Observations and Recommendations	62
14.06	Historical Reports - Date	63
	Daily Washer Report	64
15.00	troubleshooting	
15.01	Troubleshooting Basics	65
15.02	Load Count or Product Run Errors	65
15.03	Troubleshooting Table	66
16.00	specifications	
16.01	Controller Specifications	67
16.02	Gateway Specifications	68
17.00	warranty	
17.01	Limited Warranty	68
17.02	Limitation of Liability	68

1.00 overview

Safety Precautions



WARNING! Please read precautions thoroughly before operation. Meet all applicable local codes and regulations.

THANK YOU FOR YOUR INTEREST IN OUR PRODUCTS

Please use this equipment carefully and observe all warnings and cautions.

WEAR

protective clothing and eyewear when dispensing chemicals or other materials or when working in the vicinity of all chemicals, filling or emptying equipment, or changing metering tips.

ALWAYS

observe safety and handling instructions of the chemical manufacturer.
direct discharge away from you or other persons or into approved containers.
dispense cleaners and chemicals in accordance with manufacturer's instructions. Exercise CAUTION when maintaining your equipment.
reassemble equipment according to instruction procedures. Be sure all components are firmly screwed or latched into position.

KEEP

equipment clean to maintain proper operation.

1.01 System Components

- 1) Connected Total Eclipse Controller, Gray
- 2) Ethernet Cable Splitter and Terminator
- 3) Controller Interface Cable
- 4) Cable from Controller to Gateway
- 5) Cellular Gateway, SIM Card (factory installed) and RS485 Interface

The actual components delivered will depend on the configuration of the system ordered. The Connected Total Eclipse Controller can be connected to various Hydro laundry dispensers and communicates data to Hydro Connect via manual uploads or in real-time with a cellular gateway. The system may also include:

- Machine Interface – Accepts washer signals and converts them to safe, low-voltage inputs.
- Product Dispenser – Provides product transfer to the wash machine.
- Flush Manifold (optional) – Available for water flush chemical transfer applications.

The Connected Total Eclipse Controller is compatible with most Hydro laundry dispensers.

1.02 Features

The Connected Total Eclipse Controller expands on Hydro's most popular laundry controller (the Total Eclipse Controller) to bring an adaptive and easy-to-use laundry chemical management system.

The Connected Total Eclipse Controller combines the classic Total Eclipse features with updated real-time reporting and remote configuration capability through Hydro Connect.

The result is increased visibility into laundry performance with real-time reports on productivity, chemical usage, costs, and alarms and the ability to make adjustments remotely without making costly visits to site.



Connected Total Eclipse Controller



WARNING!

Connected Total Eclipse Controller Systems are intended to be installed by experienced installers, in accordance with all applicable electrical and plumbing codes.

NOTE: Always use proper lockout or tagout procedures when servicing the dispenser.



CAUTION!

This manual was written and illustrated to present the basic installation, operation and servicing instructions of the Connected Total Eclipse Controller. Guidelines are suggested in reference to the preferred method of installation, but the variety of equipment and the surrounding environment will dictate the actual installation of the Connected Total Eclipse Controller.

1.00 overview (continued)

1.02 Features (continued)

Designed for maximum versatility in OPL or large laundry wash machines, selectable operating logic allows operation with trigger signals from fully-programmable washers or with manually triggered signals (or cycle time extenders) from non-programmable, fixed-time washers. Listed below are key features of the classic Total Eclipse controller and the new features offered by the Connected Total Eclipse.

Classic Features	Description
Maximum Formula Power	Up to 48 different formulas let you tailor your chemical requirements to each wash classification. Program the controller via the keypad or upload formulas and settings from a USB flash drive that has been programmed on a personal computer using our Formula Editor software.
Eight Product Capability	Up to eight products, each with three dispense amounts (A, B, and C) and a delay, may be connected. The maximum dispense amount is 99.99 oz. (2999 ml.).
Compatibility	Use with components from earlier Hydro laundry systems or adapt to future updates by adding modular components and loading updated software at the customer's site.
Easiest Operation	User-friendly, large screen display offers seven lines of text and customized formula and product names. Setting, formula, and production information are retained even when controller is powered off. Two pre-installed languages are standard (English plus another, based upon area of sales). Language choices may include Spanish, French, Portuguese, German, and Swedish. All operating and programming menus are in the installer-selected language.
Auto Formula Select (AFS)	When used with a fully-programmable, microprocessor-controlled washer, the washer uses a timed signal to automatically select the chemical formula.
Three Calibration Methods	Calibrate by time, volume, or manually to accommodate different dispenser types and installation configurations.
Flush Interlock	Optional flush manifold (with flow switch) shuts off the dispenser if flow falls below 0.65 gallons per minute (GPM or 2.5 liters per minute (LPM)).
Security	Password protected formula programs and data reporting. A real-time clock sets date and time stamp at startup.
Connected Total Eclipse Features	Description
Enhanced Historical Reporting through Hydro Connect	Data is transferred to Hydro Connect manually via the USB drive or automatically via a cellular gateway to create professional historical reports on Production (loads and lbs/kgs run by formula), Chemical Usage by formula, Costs, and Alarms. Settings and Formulas can also be viewed in Hydro Connect.
Real-time Dashboard	View washer status, alerts and key productivity metrics in real-time to proactively pinpoint inefficiencies while reducing rewash.
Daily Washer Reports	View a daily summary of all formulas run with details on each chemical dispensed to ease troubleshooting.
Remote Configuration Capability	Change formulas or dosing parameters from anywhere with an Internet connection, saving time and money.
Two Streamlined Modes of Operation	Standard Mode and Pump Mapping offer flexibility, while also streamlining the modes of operation.

1.00 overview (continued)

1.03 Ordering Connected TE Controllers and Options

The Connected Total Eclipse Controller can be ordered as a retrofit/upgrade by selecting the number of Connected TE Retrofit Controllers (1 per washer) and one cellular gateway. If clients are unable to purchase a gateway or real-time service package, they can still enjoy historical reporting by just purchasing the controllers (no cellular gateway needed).

Step 1: Retrofit Controller for Historical and Real Time Reporting:

Kit Designator: RET = Retrofit Kit

Cable Length: 015 = 15 ft (4.5m) *

**TE Controller:
Quantity** 1

* Longer cables are available, in 50 ft (15m) increments up to 400 ft (125m) which is the maximum length allowed.

Model Builder:	Hydro Prefix	Base Model	Kit Designator	TE Controller Quantity	Cable WLength
Standard Kit					
HYDCTE-RET1015 Connected TE Retrofit Kit, 1 machine, Std 15ft cable	HYD	CTE	RET	1	015

Step 2: Gateways for Real-Time Reporting:

Service Region: NA = North America
EM = Europe, Middle East and Africa
AP = Asia-Pacific

Cable Length: 050 = 50 ft (15m)

Gateway Model: M = Cellular Gateway

Service Type: T = Basic Service

Model Builder:	Hydro Prefix	Base Model	Service Region	Gateway Model	Cable Length (feet)	Service Type
Standard Gateways						
HYDCTE-NAM050T Connected TE Gateway, NA , Type M, Std 50' cable	HYD	CTE	NA	M	050	T
HYDCTE-EMM050T Connected TE Gateway, EM , Type M, Std 50' cable	HYD	CTE	EM	M	050	T
HYDCTE-APM050T Connected TE Gateway, AP , Type M, Std 50' cable	HYD	CTE	AP	M	050	T

Step 3: Real-Time Data Package for Real-Time Reporting:

Standard Real-Time Data Package	Description
HYD-CON-TE-RTBUNDLE	Monthly Real-Time + Cell Data Fee for 1 Connected TE Gateway

1.04 Formula Editor

The optional Formula Editor reduces installation time and cost by allowing an off-site technician to create a set of efficient and cost-effective settings and formulas on a personal computer. An installer can load these Setup Files (via a USB flash drive) to multiple controller installations. With the Formula Editor, up to 48 industry-specific formulas can be quickly created and managed as part of a cohesive chemical program.

Take a Setup File (Formulas and Settings that were created with the Formula Editor software or read from a Connected Total Eclipse controller) and write the Setup File to another Connected Total Eclipse controller via a USB flash drive.

Another use for the USB Flash drive is to download data files from the controller and then upload them into Hydro Connect manually to visualize the data on a PC.

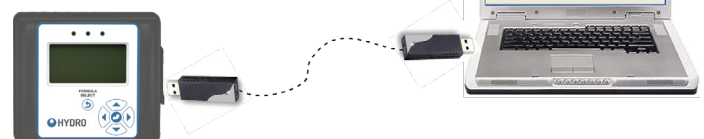
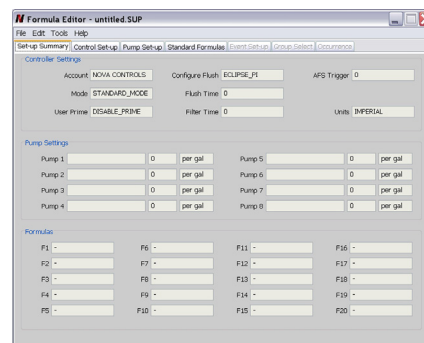

1.00 overview (continued)

1.05 Operation

The **Machine Interface** (MI) receives supply signals from the laundry machine at predetermined times in the wash formula. The MI sends these signals to the **Connected Total Eclipse controller**.

The controller functions are governed by the Operation Mode selected, the features enabled, and the formula rules. In most modes, the laundry operator can change the formula or load size, according to the load type. The controller activates the dispenser to inject specific products, based on the “supply signals” from the laundry machine for completely automatic control of each product delivery.

The MI is installed near the laundry machine control wiring area, often to the exterior of the laundry machine, and can accept supply signal voltages ranging from 24-240VAC or from 22-24VDC. The various product dispensers operate on either 115VAC at 60 Hz, 220VAC at 60Hz, or 230VAC at 50 Hz. The product dispenser is also what supplies the low voltage power to the controller and provides an interface for the optional flush manifold.

A **Flush Manifold** (optional for pumpstands) provides a way of using a water flush to transfer product to the laundry machine.

1.06 System Diagram (Manual Upload Installation)

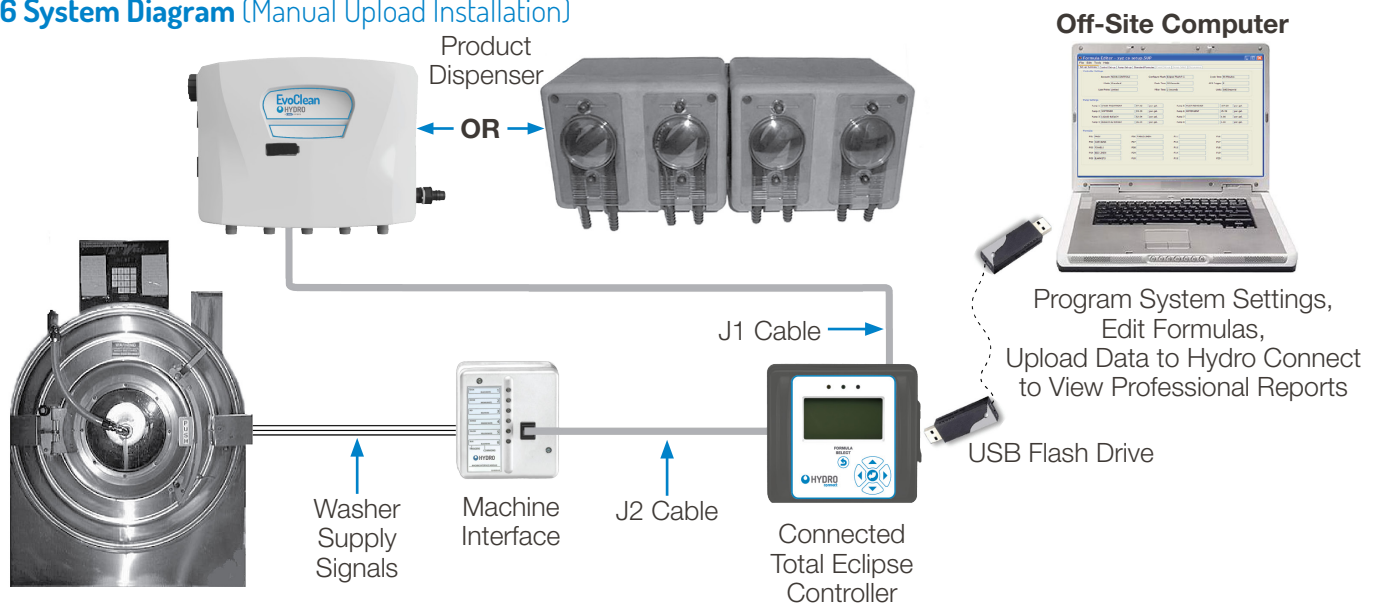

1.07 System Diagram (Real-time Streaming)

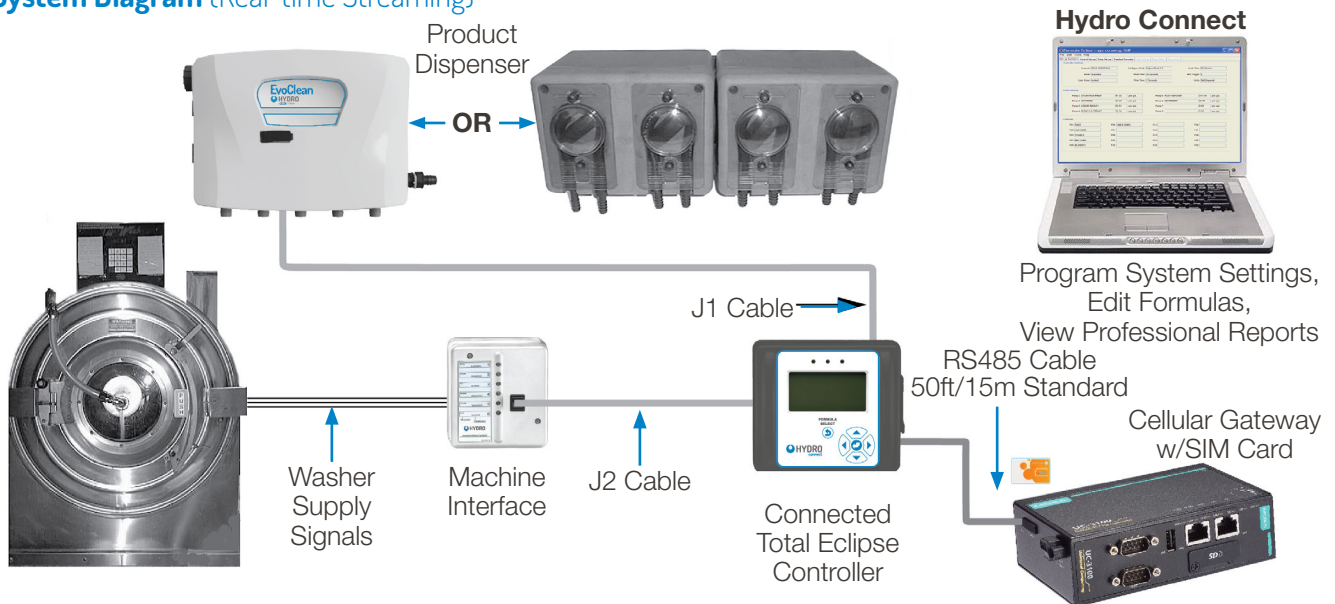

NOTE! As the traditional product dispensers have been pumps, some standard terms such as “Count Pump” and “Pump Interface” are used in this document, even though you may be using an eductor dispenser (such as EvoClean).

1.00 overview (continued)

1.08 Modes of Operation

Each operating mode has a different combination of rules for creating and editing settings. These rules affect subsequent dispensing.

When selecting a Mode of Operation, consider both the type and capabilities of the laundry machine and the variety of linen to be washed.

Use the following table to compare modes. The read the following sections for a detailed explanation of each Operating Mode and the accompanying feature.

Operation Mode	Count Pump	AFS ¹	8 Products	Simultaneous Run (Non-Flush)
Standard	Yes (selectable)	Yes	Yes ²	Up to 6 products
Pump Mapping	Yes (selectable)	Yes	Yes	Up to 3 products

¹ AFS is intended for use with fully-programmable, microprocessor-controller laundry machines.

² 8-Product control is allowed, but products 3 and 7 are linked to each other, as are products 5 and 8 linked to each other.

1.09 Standard Mode (default)

The most common mode used for North American installations, Standard Mode allows the operator to quickly select a formula from a list of formulas.

A formula can include up to 8 products, each with three possible programmable amounts (A, B, and C amount).

Each washer trigger signal notifies the corresponding product to dispense the set amount (i.e. trigger 1 starts product 1, trigger 2 starts product 2, etc.).

All amounts and delays are based on the currently selected formula.

Non-flush systems can dispense up to six (6) products simultaneously. Please note that educator dispensers have a built-in flush manifold, always utilize flush and therefore cannot dispense products simultaneously.

Standard Mode is the only mode that features Auto-Formula Select via the AFS Trigger.

When using an 8-product pump interface (PI) this mode links products 3 and 7 to each other and links products 5 and 8 to each other. (See also: "Formula Rules" on page 13 for dispensing rules and exceptions.)

1.10 Pump Mapping Mode

In the Pump Mapping Mode, the six trigger signals are placed into four, predefined wash steps (see the following table).

Wash Step	Trigger Signal Inputs
Prewash	Trigger 1
Auto-Formula Select	Trigger 2
Mainwash (2H/2C)	Trigger 3 and / or 4
Spare	Trigger 5
Final Rinse	Trigger 6

- Between 0 and 3 products may be assigned to each wash step. A product may be used in more than one wash step.
- The trigger signals determine which wash step and products dispense their programmed formula amounts, and in which order.
- All dispensed amounts and delays are based upon the currently selected formula.

2.00 features and options

2.01 Auto Formula Select (AFS)

AFS allows the installer to choose a trigger signal that will select and run any programmed formula using a timed signal.

The AFS signal does not need to be qualified by a Filter Time when it is selecting a formula. After a formula has begun, the trigger chosen for AFS may also be used as a product trigger, which must then be qualified by the Filter Time before the dispense will occur.

The AFS trigger should not be a trigger signal that starts or ends a formula. (The first product triggered starts the formula and the Count Pump ends the formula.) The AFS trigger signal must occur before a wash cycle begins or after a wash cycle has ended, not while a formula is running. The washer supply signal must be programmed for a total of 2 seconds multiplied by the desired formula, for example:

a **2-second** signal = **Formula 01** ... a **4-second** signal = **Formula 02** ... a **6-second** signal = **Formula 03** ...

When AFS begins, the controller displays “SELECTING F[##].” Every two seconds, the next formula number [##] displays, until such time as the signal ends, at which point the selected formula is displayed again (e.g. if the washer supply signal is set for 20 seconds, F10 WHITE SHEETS is selected to run and displays on the Home Screen).

2.02 Count Pump

In all Modes of Operation a Count Pump is used to determine when the wash cycle is completed. The system records a complete wash cycle after all programmed amounts for the Count Pump are dispensed.

In Standard and Pump Mapping Modes the default Count Pump is the highest number for which an amount is programmed. The default Count Pump may be overridden by the installer, who may select a Count Pump other than the default.

The Count Pump can correctly register a load only if the following three conditions are met:

- At least one amount is programmed for the Count Pump.
- The Count Pump must be the last to run.
- The Count Pump is requested to run for all programmed amounts. If two or three amounts have been assigned to the Count Pump, it must be requested to run at least two or three times, respectively.

2.03 Flush Operation (ONLY for a flush-compatible PI - NOTE: Eductor PI's are all flush-compatible.)

Flush prevents incompatible chemicals from combining. When a flush-compatible Pump Interface (PI) is selected during Initial Set-up, flush can be enabled by setting a Flush Time, up to 99 seconds.

For all flush compatible PI's (except eductor PI's) if the Flush Time is set to zero (0), flush is disabled. For eductor PI's the allowable flush time range is 10 to 99 seconds.

When Flush is enabled:

Only one product can be dispensed at a time. If there is a request for multiple products to dispense at the same time, a flush-enabled system causes each product to dispense sequentially. (See also “Trigger Spacing and Product Queue” on page 13.)

- A fixed, 2 second pre-flush occurs before the product dispenses.
- Flush occurs continuously for the entire time the product is dispensing.

2.04 Non-Flush Operation

Allows from three to six products to run simultaneously, depending upon the Mode of Operation selected.

Systems using an eductor dispenser, which always uses flush, cannot run products simultaneously.

2.05 Formula

A formula specifies which product dispenses and in what order when a trigger signal is received. A product may be set to dispense multiple times, with up to three different amounts (identified as Amounts A, B and C) and a delay. A product will only dispense when at least one amount (not zero) is set. A formula may also establish a default load weight, a name that is added to the formula number and, in some Operation Modes, the Count Pump number.

2.00 features and options (continued)

2.06 Formula Rules

Standard Mode:

If only the A amount is programmed for a product in a formula, the first request results in the dispensing of Amount A. Additional requests within the same wash cycle are ignored.

If only A and B amounts are programmed for a product in a formula, the first request results in the dispensing of Amount A and the second request results in the dispensing of Amount B. Additional requests (after the second request) are ignored.

If all three amounts (A, B, and C) are programmed for a product in a formula, the first request results in the dispensing of Amount A, the second request results in the dispensing of Amount B and the third request results in the dispensing of Amount C. Subsequent requests (after the third) result in the dispensing of Amount C. The dispensing sequence is reset when the wash cycle ends.

Pump Mapping Mode:

In Pump Mapping Mode, pumps that are allocated to Prewash (Trigger 1) will only dispense the A amount. Amounts entered for B and C amounts will be ignored.

Pumps allocated to the Mainwash (Trigger 3 and 4) will dispense the B amount on the first trigger and the C amount on the second trigger. Amounts entered for A will be ignored.

Pumps allocated to the Spare (Trigger 5) and Final Rinse (Trigger 6) will dispense the A amount on the first trigger, the B amount on the second, and the C amount on the third trigger. The dispensing sequence is reset when the wash cycle ends.

2.07 Trigger Spacing and Product Queue

Products can be triggered to dispense in several different ways, depending on the Mode of Operation. If a trigger for a product to run occurs and the product is already dispensing, the trigger is ignored. In Pump Mapping mode, this could result in not running some or all of the products called for by a trigger signal.

With a Pump Interface (PI) with Flush enabled, different products that attempt to run simultaneously are placed in a queue and then dispense in sequence. A product is added to the queue whenever there is a valid trigger for it, as long as it is not currently running and is not already in the queue. The queue allows for up to 7 products (other than the currently dispensing product), to be “queued up” (waiting to dispense in sequence).

NOTE: It is imperative that the installer allow plenty of time between triggers to ensure that a product (or group of products) will dispense for each of its triggers.

2.08 Trigger Signal Filter Time

Signal filter time is the amount of time that a trigger must remain continuously ON before being recognized as a qualified trigger and starting the dispense. The factory default time is 2 seconds. Longer times (10, 20, 30, 60 or 90 seconds) may be set if washers present problems, i.e., unreliable signals falsely triggering dispenses. The Auto Formula Select (AFS) signal does not use a signal filter time.

2.09 8-Pump Interface

Regardless of the selected Mode of Operation or the Flush setting, products 3 and 7 and products 5 and 8 cannot run simultaneously on an 8-Pump Interface. They can be requested to run at the same time, but they will run sequentially, based on the Mode of Operation, product order, or delays set.

Standard Mode:

In Standard Mode, products 3 and 7 are triggered by the same trigger signal, Trigger 3. Products 5 and 8 are also triggered by the same trigger signal, Trigger 5.

If Amounts A, B, and C are programmed for both product 3 and product 7, then on the first instance of Trigger 3, product 3 Amount A will dispense and then product 7 Amount A will dispense. On the second instance of Trigger 3, product 3 Amount B will dispense and then product 7 Amount B, and so on.

Pump Mapping Mode:

In Pump Mapping Mode, up to 3 products can be assigned to each Pump Map.

The A, B, and C amounts will dispense according to the pump map they are assigned to. See section 10.01 “Formula Rules” on page 41 for more information.

2.00 features and options (continued)

2.10 Acronyms and Abbreviations

The following is an alphabetized list of Acronyms and Abbreviations (with definitions) that are found in the Total Eclipse controller and/or in this installation, programming and operation manual.

Acronym / Abbreviation	Definition
CALIB	Calibration
F01	Formula Number One
FAT or FAT32	Formatting Needed on USB Flash Drive
GAL	Gallon
GPM	Gallons per Minute
ID	Identifying Number of Software
INSTL	Installer (used in INSTL PASSWORD)
KG	Kilogram
LB	Pounds
L	Liters
LCD	Display Screen on Total Eclipse Controller
LNG	Total Eclipse Controller Language File
MAX	Maximum
MI	Machine Interface
Min	Minutes
ML	Milliliters
OZ	Ounces
PI	Pump Interface
P1	Product Number One
P1A - P1B - P1C	Product Number One, "A" Amount - Product Number One, "B" Amount - Product Number One, "C" Amount
SAE	United States Units of Measurement (OZ, LB, GAL)
SEC	Seconds
CTE	Setup File

3.00 installation

3.01 Machine Interface Installation

- 1) Route MI signal wires through knock-out on washer within the wiring area (approximately 3/4 inch or 20mm). Use lock nut on MI nipple to secure MI to washer.

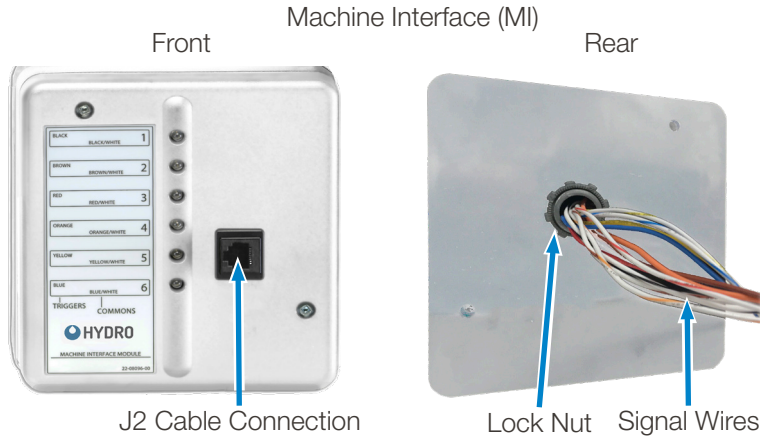

- 2) Connect cable marked J2 into Machine Interface. Bundle excess J2 cable outside washer and connect other end to the connector labeled J2 on the rear of the Controller.
- 3) Connect cable marked J1 from the dispenser module to the connector labeled J1 on the Controller.
- 4) For additional cable strain relief, secure J1 and J2 cables to controller tie-down posts with cable ties (aka tie wraps, zip ties).

Connected Total Eclipse Controller (rear)

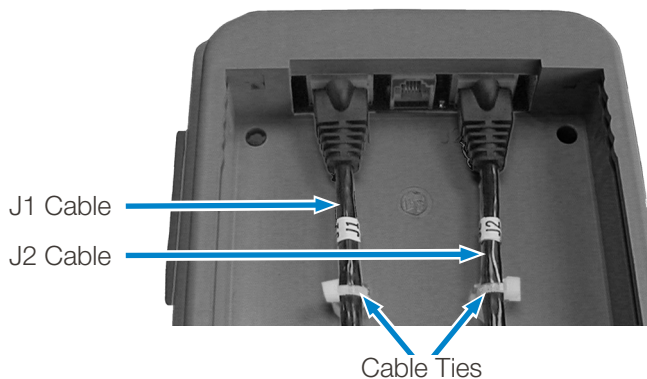

3.02 Signal Wire Installation

The Machine Interface will work with any signal voltage between 24 – 240VAC or 22 – 24VDC. With DC signals, polarity must be observed, where common connects to negative. The signals must be positive voltages.

Supply Trigger Wiring:

- 1) Identify the washer supply signals. Check with technical service or with the washer manufacturer if you are not sure of the connections.
- 2) Identify the Mode of Operation to be used. Use appropriate terminal connectors to connect the signal wires to the Machine Interface wires, based upon the table on the next page.



WARNING! The Connected Total Eclipse controller is intended to be installed by a qualified technician only, in accordance with all applicable electrical and plumbing codes.



DISCONNECT POWER to the laundry machine and dispenser during installation and/or any time the dispenser cabinet is opened.



WARNING! Keep the Machine Interface and the communication cables away from high voltage wires and relays. NEVER run the J1 and J2 cables parallel with high voltage lines.

NOTE: This manual describes only the installation and programming of the Connected Total Eclipse Controller, which is a portion of the larger Chemical Management System. Please refer to the reference manual included with your dispenser or upgrade kit for additional instructions.

Electrical wiring connections for supply triggers are to be done inside the supply junction box. (See section 3.03 “Supply Trigger Wiring” on page 16 for detailed connection information.)

NOTE: The maximum distance for the J1 cable from the product dispenser to the controller is 75 feet or 22 meters.

- “J” cables are available in 15 and 30 foot lengths (4.5m and 9m). A coupler is available to join cables together for longer distances, but they must always be under 75 feet or 22 meters.
- “J” cable runs longer than 75 feet or 22 meters require the use of break out boxes and hard wiring. Contact Hydro Systems for details.



WARNING! Always verify all voltage sources with a voltage meter.



DISCONNECT POWER to the laundry machine and dispenser during installation and/or any time the dispenser cabinet is opened.

3.00 installation (continued)

3.03 Supply Trigger Wiring

Supply Trigger Wiring by Operation Mode

Trigger	Supply Signal	Signal Common	Connect by Operating Mode to:	
			Standard	Pump Mapping
Signal 1	Black Wire	White & Black Wire	Product 1	Prewash
Signal 2	Brown Wire	White & Brown Wire	Product 2	AFS
Signal 3	Red Wire	White & Red Wire	Product 3	Mainwash (2H/2C)
Signal 4	Orange Wire	White & Orange Wire	Product 4	Mainwash (2H/2C)
Signal 5	Yellow Wire	White & Yellow Wire	Product 5	Spare
Signal 6	Blue Wire	White & Blue Wire	Product 6	Final Rinse

3.04 Trigger Signal Wiring Notes

- If one or more product signals are not used, they do not need to be connected.
- If you are triggering more than one product from a single signal, connect all of the Machine Interface signal wires for those products to that signal.
- Protect any unused wire with a wire nut or an insulated connector. If the washer has only a single common, connect all the common wires together.
- One of the 6 LEDs on the Machine Interface will light up when the corresponding valid signal is received.

3.05 Cellular Gateway Installation

One cellular gateway is needed for up to four Connected Total Eclipse controllers, for real-time connectivity. To install the cellular gateway follow the steps below:

1) Using a cellular signal strength indicator or the powered gateway (120 or 240 VAC depending on the model) determine a suitable mounting location for the gateway that is close to the washers and dispensers (standard cable length is 50 feet or 15 meters, but this cable can be as long as 400 feet or 125 meters) and has adequate cellular signal. Hydro's recommendation is that the gateway have a good or excellent connection to minimize outages or data loss (see LED table on next page).

2) The gateway can be physically mounted using either the included DIN Rail kit or a third-party enclosure (not included).

DIN Rail: The aluminum DIN-rail attachment plate is already attached to the product's casing. To mount the UC-3100 Gateway onto a DIN rail, perform the following steps.

- a) Pull down the bottom slider of the DIN-rail bracket, at the back of the unit. (Down is toward the power connection.)
- b) Insert the top of the DIN rail into the slot just below the upper hook of the DIN-rail bracket.
- c) Latch the unit firmly onto the DIN rail.
- d) Once the gateway is mounted properly, you will hear a click and the slider will rebound back into place automatically. The two antenna connectors should be facing upward when mounted correctly.

3.00 installation (continued)

3.05 Cellular Gateway Installation (continued)

3) Connect the interface board (included in the gateway package) to the Serial Port labeled COM2.

RS485 Interface Board



Serial Port Connection Pins

Serial Port (COM2)



This RS485 interface board may be installed on up to four Connected TE controllers to establish communications with the gateway.

4) Using the provided interface cables (1 per Connected TE), daisy chain each cable splitter and Connected TE together, as shown below. The splitter closest to the gateway would be connected to the gateway interface board via the long interface cable (provided with the gateway). The splitter furthest from the gateway should have its open port plugged with the provided terminator.

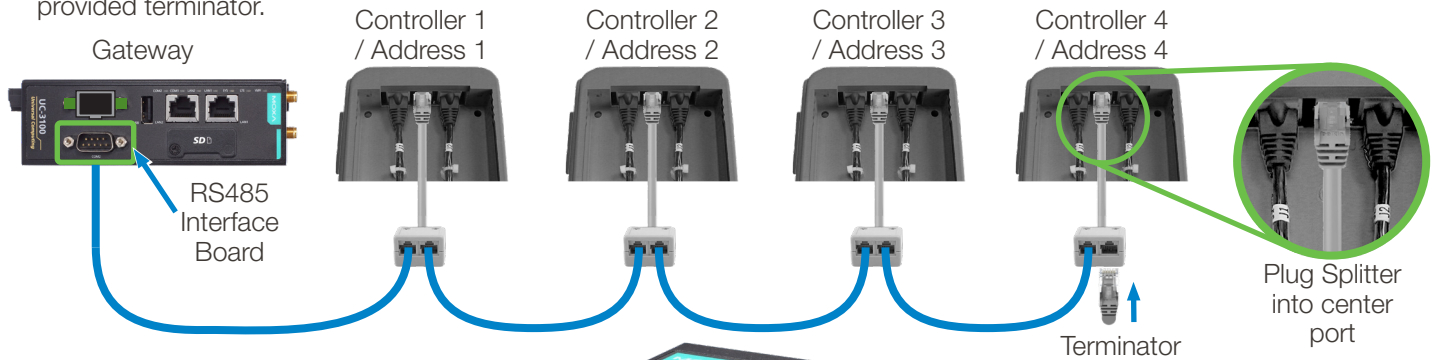

5) Install the two Cellular Antennas by screwing them onto the threaded ports **C1** and **C2** as indicated. When installed correctly, the antennas should be facing upwards.

NOTE: Both antennas **MUST** be connected.



6) Connect the power jack (included in the gateway package) to the gateway UC-3100's DC terminal block (located as shown to the right), and then connect the power adapter.

It takes several seconds for the system to bootup. Once the system is ready, the SYS LED will light up green.



7) With everything connected, ensure that the SYS LED illuminates green (see table to right) and the LTE Cellular signal strength LEDs are denoting Good or Excellent.



LED Name	Status	Function	Notes
SYS	Green	Power is on	
	Red	No signal	
	Off	Power is off	
LAN1/ LAN2	Green	10/100 Mbps Ethernet mode	
	Off	Ethernet port is not active	
COM1/ COM2/ CAN1	Orange	Serial/CAN port is transmitting or receiving data	
	Off	Serial/CAN port is not active	
Wi-Fi	Green	Wi-Fi connection has been established	Client mode: 3 levels with signal strength 1 LED is on: Poor signal quality 2 LEDs are on: Good signal quality All 3 LEDs are on: Excellent signal quality AP mode: All 3 LEDs blinking at the same time
	Off	Wi-Fi interface is not active	
	Off	Cellular interface is not active	
LTE	Green	Cellular connection has been established	3 levels with signal strength 1 LED is on: Poor signal quality 2 LEDs are on: Good signal quality All 3 LEDs are on: Excellent signal quality
	Off	Cellular interface is not active	
	Off	Cellular interface is not active	

8) Before streaming data, check in Hydro Connect to confirm that the gateway is assigned to the correct site. If it is not, contact the chemical company or Hydro admin.

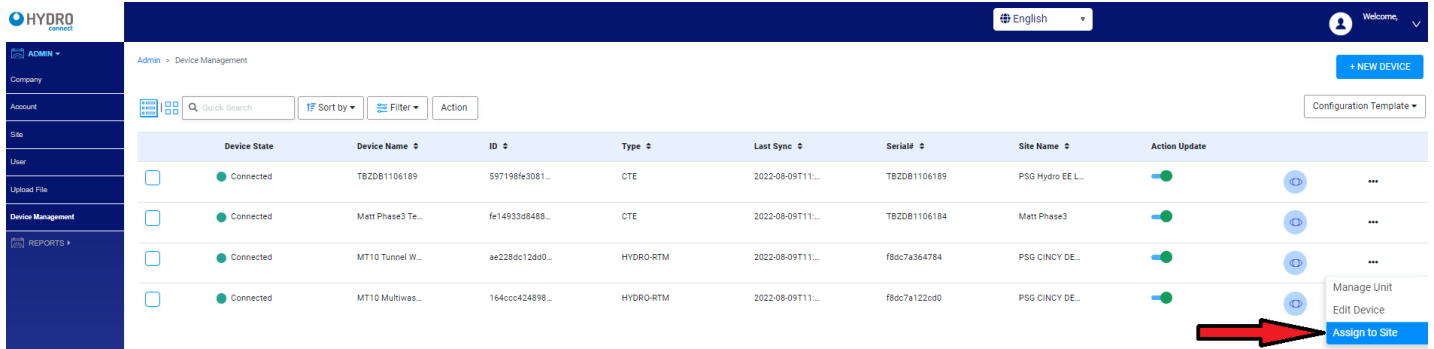

To confirm site navigate to Device Management and Click on Assign to Site

3.06 Connected Total Eclipse Controller Mounting

The Connected Total Eclipse controller may be mounted either horizontally (such as on top of the washer) or vertically (such as on the front of the washer). Mount the unit using the self-adhesive strips provided, or for added security, you may use nuts and Allen bolts or other fasteners (provided) as is appropriate to the mounting surface.

- 1) Position the controller for easy access to the keypad and display screen.
- 2) Mark a mounting location that is on, or close to, the washer. The mounting surface must be clean and dry.
- 3) Join the four Velcro-style strips firmly together to form two pair.
- 4) Peel backing from one strip of each pair and place, adhesive-side down, in each recess on the mounting bracket. Press firmly for good adhesion.
- 5) Peel backing from opposite strips and press mounting bracket onto smooth, clean surface (use alcohol wipe, if needed) at marked location.
- 6) With cables connected, slide controller front down onto mounting bracket (controller back), guiding cables into slots and pressing down firmly until front and back snap into place.

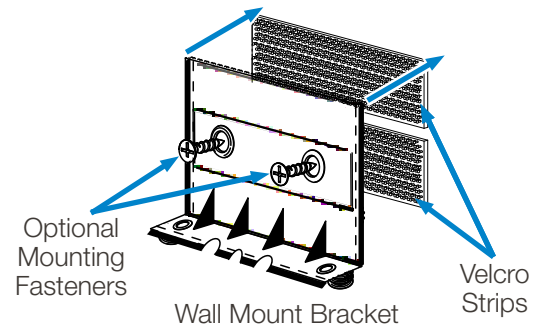

4.00 initial controller setup

4.01 Set Operating Language

After all electrical, plumbing, and mechanical installation is complete, apply power to the Connected Total Eclipse Controller.

At the first power up, the LANGUAGE menu follows the splash screen to allow menu language selection.

Choose one of the menu languages that are pre-installed in each controller (English or Spanish for the Americas; English or German in the EU); or download additional Connected Total Eclipse Controller menu language files from the Hydro Systems' website to a USB flash drive.

Installing a language from a USB flash drive to a controller can only replace the non-English menu language in the controller as the English language option is permanently installed.

1) Move the selection box, using the Up / Down arrow keys,   until it frames your desired language (US controller defaults shown below).

(Optional) To replace the non-English language with a different language connect a USB flash drive containing the downloaded languages to USB port "A" (the lower USB port on the controller's right side). Available languages will appear for selection.

2) Press the Enter key  to select the operating language and launch the DATE & TIME menu.

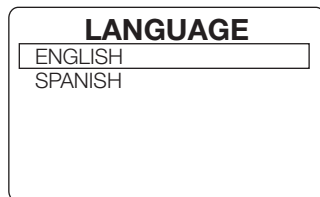

US Default Language Menu



With USB Language Drive

4.02 Changing Operating Language After First Power Up

1) Shut off power to Total Eclipse by unplugging the J1 cable or shutting off dispenser power switch. (Settings and logged data are retained.)

2) Connect a USB flash drive and restore power. The LANGUAGE menu will appear.

3) Select the other operating language on the controller, or select a different language file that may be contained on the USB flash drive. Formulas and setup information (operating mode, calibration, etc.) are retained when a operating language is changed. Custom formula and product names are not translated when a change is made to the operating language.

4.00 initial controller setup (continued)

4.03 Setting the Date, Time and Time Zone

After setting the operating language on the first power-up from the factory, or whenever the controller is powered up afterward, the DATE & TIME menu is displayed.







When installing the controller, you **must** change the Date, Time, and Time Zone to match the installation location, as this controls the data contained in reports. **NOTE:** If using more than one Connected Total Eclipse Controller with the cellular gateway, ensure all the dates and times are similar.

The display is in ISO 8601 standard format: **YYYY-MM-DD HH:MM** (Year-Month-Day Hour: Minute). The clock is a 24-hour clock, with no AM/PM setting.

After doing this, user will also need to set the time zone so that the reports in Hydro Connect display the correct time. There are nine pre-configured time zones, with the ability to set a custom time zone offset to the UTC time (-12 hours to +14 hours).

Once set, the date and time (real-time clock) are retained by battery power if the main power is turned off or if there is a power failure.



Setting the Date and Time:

- 1)  The first number of the year is selected as the active digit, indicated by the double-arrow cursor.
- 2)   You can change the value of the active digit by pressing the Up / Down arrow keys.
- 3)   To move to the next digit, press the Right arrow key. To backspace, press the Left arrow key.
- 4)  When the correct date and time are displayed, press the Enter key to save the settings and launch the Total Eclipse Home Screen (see section 6.02 "Home Screen" on page 23 for more information).

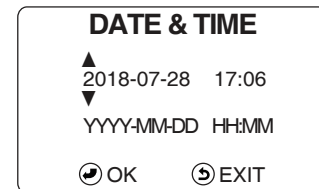
Note:  To exit the Date & Time menu without saving changes and move to the Home Screen, press the Exit key. Also, the display will automatically exit the Date & Time menu if no keys are pressed for 15 seconds, without saving changes.



Setting the Time Zone:



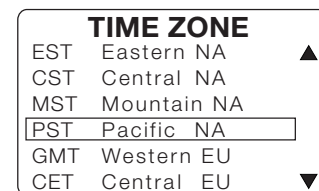

- 1)   Select the time zone that reflects the area of the world of the installation. There are 9 preset time zones with an offset from Universal Time Coordinated (UTC). If the time zone is not listed, a custom offset can be entered. The time zones are:
 - Eastern NA (-5)
 - Central NA (-6)
 - Mountain NA (-7)
 - Pacific NA (-8)
 - Western EU (+0)
 - Central EU (+1)
 - Eastern EU (+2)
 - Thailand (+7)
 - China (+8)
 - Custom (-12 to +14 adjustable)
- 2)  When the correct time zone/offset is indicated, press the Enter key to save the setting.



4.00 initial controller setup (continued)

4.03 Setting the Date, Time and Time Zone (continued)

Setting the Time Zone: (continued)

- 3)   If a custom time offset is needed select CUSTOM and press the Enter key.
- 4)   Use the up/down buttons to set the offset at any value from -12.00 HR to +14.00 HR in 0.25 (15 minute) increments. The four sets of double-arrow cursors indicate that all digits will increase or decrease at the same time.
- 5)  When the correct custom time zone/offset is complete, press the Enter key to save the setting.

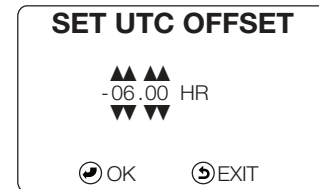
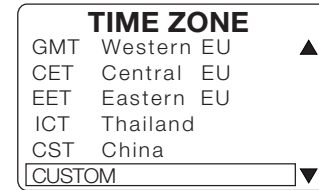

4.04 Setting the Date, Time and Time Zone After Initial Power-Up

Moving to the DATE & TIME Menu:

- 1) From the INSTALLER MENU, select INITIAL SYSTEM SETUP, and press the Enter key. The SYSTEM SETUP menu will be displayed.
- 2) Move the selection box to SET DATE AND TIME and press the Enter key. The DATE & TIME menu will be displayed.
- 3) Follow the steps in the previous section named “Setting the Date, Time and Time Zone”.

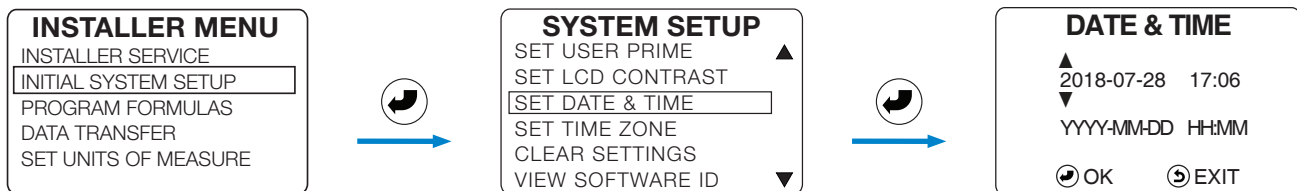

Moving to the TIME ZONE Menu:

- 1) Move the selection box to SET TIME ZONE and press the Enter key. The TIME ZONE menu will be displayed.
- 2) Follow the steps in the previous section named “Setting the Date, Time and Time Zone”.

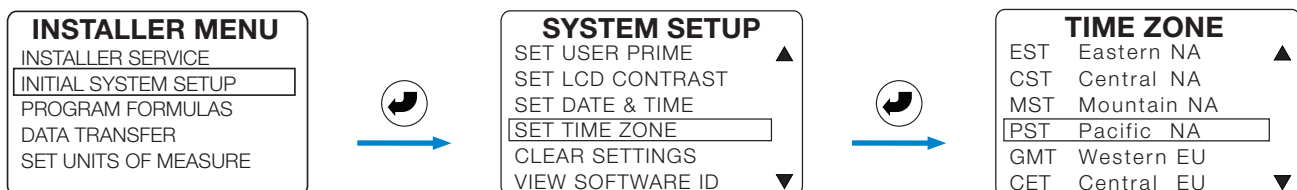

4.00 initial controller setup (continued)

4.05 Gateway Communication

When the controllers are powered, completely configured (using the steps below), and connected correctly to the gateway verify that the connectivity heartbeat is flashing in the lower right-hand corner of the display.

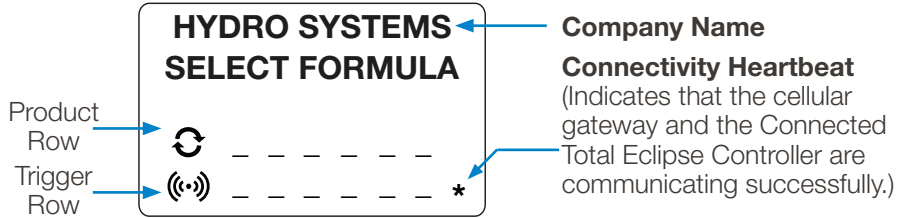

5.00 controls

5.01 Overview

The Connected Total Eclipse Controller's back-lit screen displays seven lines of text, with on-screen prompts, in the operating language selected by the installer.

A green LED indicates power is on. The six-button keypad is used by the machine operator for formula selection and modification during normal operation; and by the installer during installation, service, and data transfer.

The USB port accepts a Type-A USB flash drive (8 GB or smaller). It is used to read and write formulas and settings between the flash drive and the controller.

A USB flash drive can also be used to write Report files from the controller to the USB drive. These files can then be manually uploaded to Hydro Connect in cases where a cellular gateway and real-time streaming is not enabled.

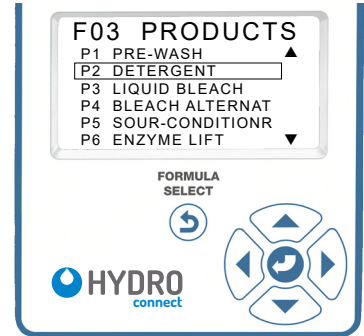

5.02 Menu Navigation

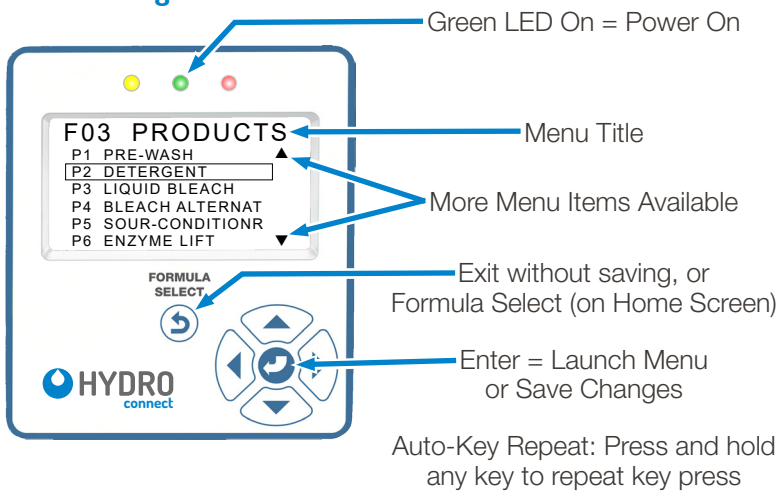

NOTE: Press the Enter key to **save** your setting changes and return to a previous menu.

Press the Exit key to **cancel** changes without saving, and return to a previous menu.

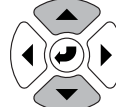

Up / Down Arrows

- 1) Moves Selection Box
- 2) Changes Digit Value

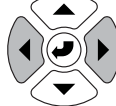

Left / Right Arrows

During edits they move the Digit Selection Cursor: ⬆️

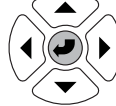













Enter / Save Key

- 1) Launch Selected Menu
- 2) Save Changes and Exit

6.00 operator menus

6.01 Keys and Menu Symbols

Button / Symbol	Operator Menus	Installer Menus
 <ul style="list-style-type: none"> 1) Enter a Menu 2) OK 3) Start 4) Stop 	<ul style="list-style-type: none"> • Select Menu Item. • Save Changes. • Start or Stop Prime or Flush. 	<ul style="list-style-type: none"> • Select an item with screen prompt “OK”. • Save Changes and exit menu. • Start or Stop an Action.
 <ul style="list-style-type: none"> 1) Exit Menu (without saving changes) 2) Formula Select 	<ul style="list-style-type: none"> • Return to Previous Menu (changes not saved). • Press & HOLD to return to Home Screen (changes not saved). • Jump to select formula from list of formulas. 	<ul style="list-style-type: none"> • Exit to Previous Menu (changes not saved). • Press & HOLD to return to Home Screen (changes not saved).
 <p>Up / Down Arrows</p>	<ul style="list-style-type: none"> • Move Selection Box to menu item. • Change Load Weight (change digit value). • Enter Password (change digit value). 	<ul style="list-style-type: none"> • Move Selection Box to menu item. • Edit numbers (0-9), letters (A-Z), hyphen (-), underscore (_), or space.
 <p>Left / Right Arrows</p>	<ul style="list-style-type: none"> • Move Digit Selection Cursor left and right. 	<ul style="list-style-type: none"> • Move Digit Selection Cursor left and right.
 <p>Selection Box</p>	<ul style="list-style-type: none"> • Indicates Formula that will be selected. • Indicates Menu that will be launched. 	<ul style="list-style-type: none"> • Indicates Menu that will be launched. • Indicates Menu Item that will be selected. • Indicates Product or Formula that will be edited.
 <p>Digit Selection Cursor</p>	<ul style="list-style-type: none"> • Indicates the digit that you can edit. 	<ul style="list-style-type: none"> • Indicates the digit that you can edit.
 <p>Scroll Arrows (additional items available)</p>	<ul style="list-style-type: none"> • Indicates additional menu items are off-screen. (Use Up / Down Arrow keys to see the items.) 	<ul style="list-style-type: none"> • Indicates additional menu items are off-screen. (Use Up / Down Arrow keys to see the items.)
 <p>Product Dispensing Row Icon (On Home Screen)</p>	<ul style="list-style-type: none"> • Identifies row where Product Dispensing shown. (On Home Screen) 	<ul style="list-style-type: none"> • Identifies row where Product Dispensing shown. (On Home Screen)
 <p>Trigger Signal Row Icon (On Home Screen)</p>	<ul style="list-style-type: none"> • Identifies row where Trigger Signals are shown. (On Home Screen) 	<ul style="list-style-type: none"> • Identifies row where Trigger Signals are shown. (On Home Screen)
 <p>Product Dispensing (when flush disabled)</p>	<ul style="list-style-type: none"> • Black bars moving left to right indicate product being dispensed or priming (when flush disabled). 	<ul style="list-style-type: none"> • Black bars moving left to right indicate product being calibrated or priming (when flush disabled).
 <p>Product Dispensing (when flush enabled)</p>	<ul style="list-style-type: none"> • White bars moving left to right indicate product being dispensed or priming (when flush enabled). 	<ul style="list-style-type: none"> • White bars moving left to right indicate product being calibrated or priming (when flush enabled).
 <p>Flushing Only</p>	<ul style="list-style-type: none"> • Solid black bar indicates flushing only. 	<ul style="list-style-type: none"> • Solid black bar indicates pre-flush before dispensing.

Operator Menus allow the Operator to:

- View Current Formula Information.
- Select the Formula to Run.
- View or Change Load Weight (One Cycle).
- Stop Dispensing in an Emergency.
- Prime Products (if priming is enabled).
- Manually Flush.

Installer Menus allow the Installer to:

- Perform Initial System Setup.
- Program and Name Formulas.
- Name Products and Calibrate Dispensing.
- Set Mode of Operation.
- Configure Flush.
- Perform Periodic Service.
- Use Transfer Data Menu:
 - 1) Write Reports to USB Drive.
 - 2) Transfer Formulas and Settings to USB Drive.

6.00 operator menus (continued)



6.02 Home Screen

The Home Screen appears after the controller language has been selected (See Set Operating Language on page 18 for more information) or whenever the controller is active.

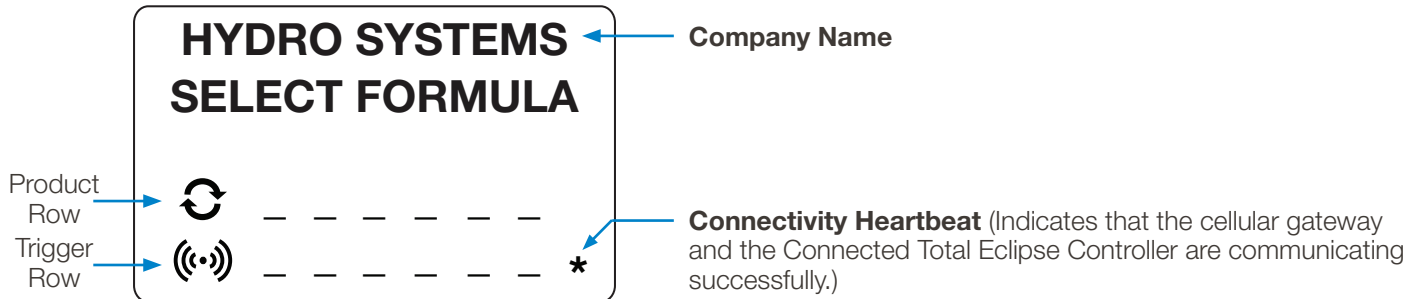
Home Screen: (Idle - No formula running.)





Hot Keys:

-  Exit = Quick Formula Select.
-  Enter = Go To Main Menu.

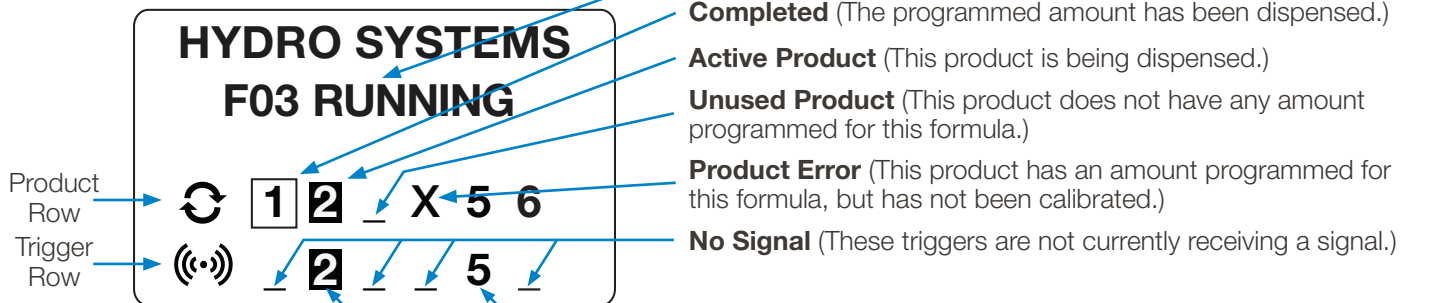
Home Screen: (Active - Formula running.)







Hot Keys:

-  Exit = Quick Formula Select.
-  Enter = Go To Main Menu.

6.03 Formula Quick-Select

To prevent data logging errors, the operator must select a formula before washer operation starts; and all programmed products must be triggered during the cycle.

- 1)  From the **Home Screen** press the **Exit / Formula Select** key.
- 2)  Press the **Up / Down Arrow** keys to move selection box to the correct formula. All formulas appear, but only formulas with programmed products are selectable.

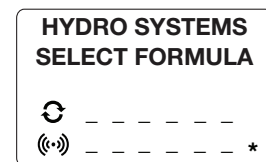
- 3)  Press the **Enter** key to select the formula and return to the **Home Screen**, which will display the new formula selected.
- 4)  (Optional) Press the **Enter** key to go the **Main Menu** where the load weight can be adjusted.

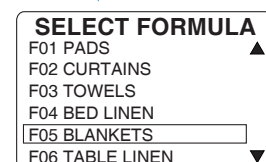

 Press Exit to Launch Select Formula Menu



-  Press Up / Down Arrows to move Selection Box
-  Press Enter to Select Formula

6.00 operator menus (continued)

6.04 Main Menu

To reach the **Main Menu** from the **Home Screen** press any key (except the **Exit** key).

Main Menu:

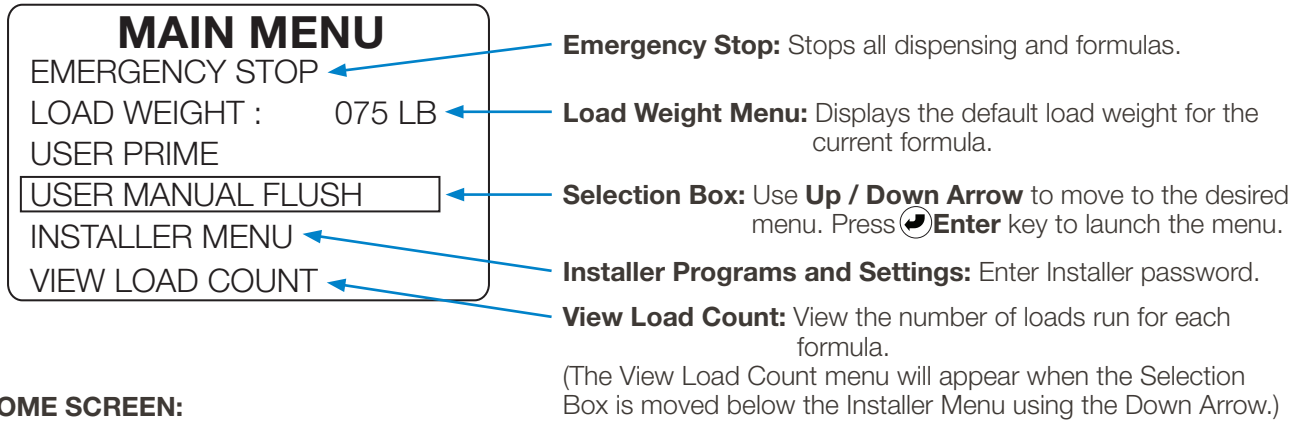

Return to HOME SCREEN:

 You can press the Exit key, or wait 15 seconds without pressing any keys.

(Operator Menu Tree shown on next page.)

6.00 operator menus (continued)

6.05 Operator Menu Tree (All Menus)

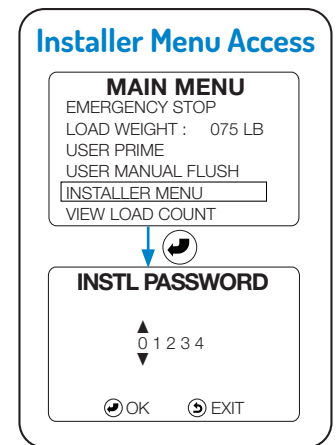
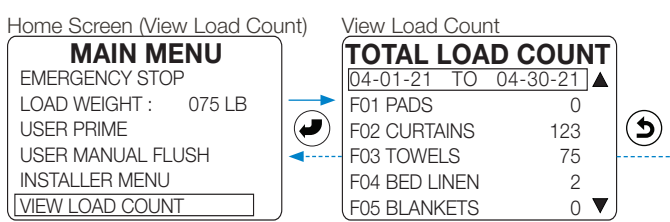
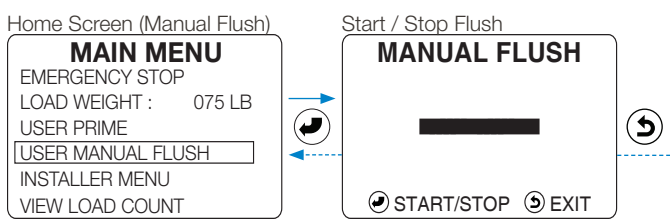
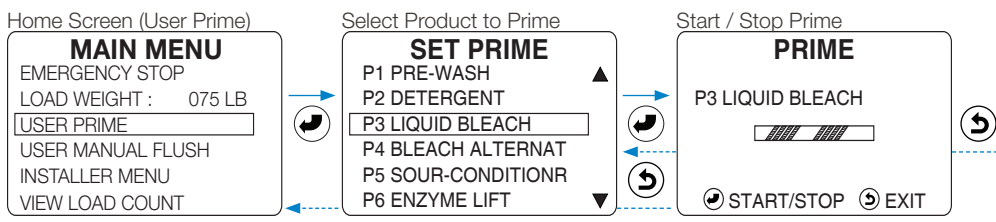
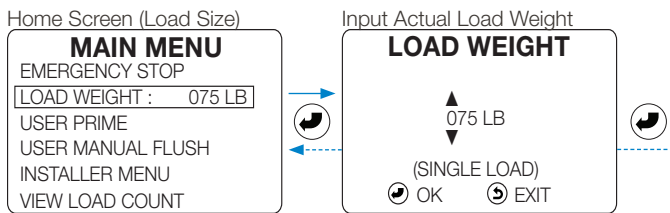
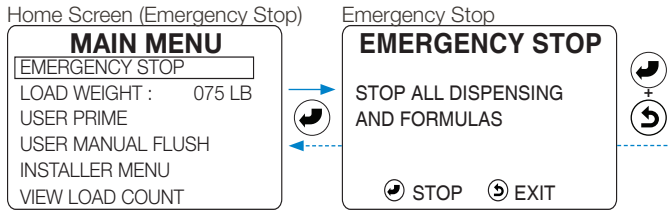
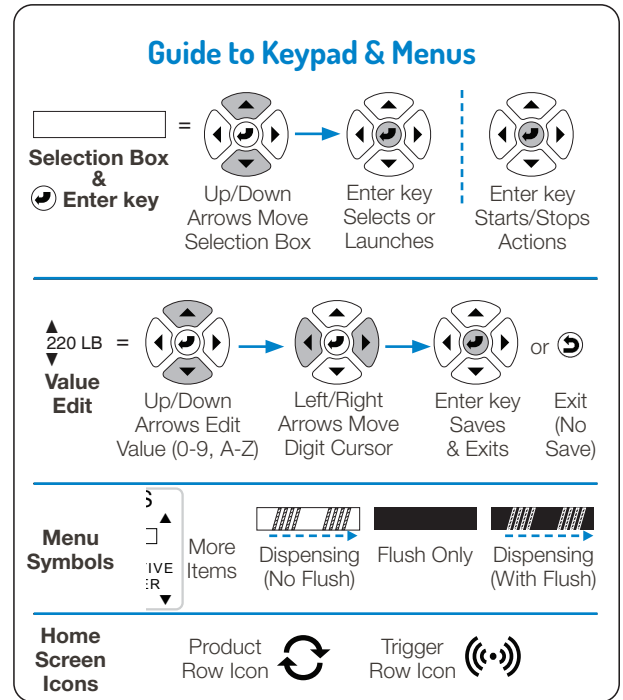
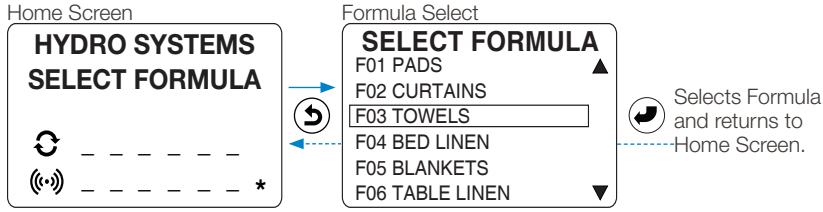

6.00 operator menus (continued)

6.06 Operator Main Menu



Note! “Power Saver”: If the display is on some screen other than the Home Screen, and there are no key presses for 15 seconds, the display reverts to the Home Screen.

If the controller is idle (no key presses and no cycle activity) for 15 minutes, the **Power Saver** feature shuts off the display backlight. Pressing any key returns the controller to normal operation.

At the Home Screen, press any key (except Exit) to launch the MAIN MENU. On the MAIN MENU, the operator can:

- Activate the emergency stop.
- Input load size (if different from default).
- Prime or manually flush (if enabled).
- Access the password-protected INSTALLER MENU, which includes programming, setup and maintenance menus.

6.07 Emergency Stop

Stops all dispensing and cancels the formula currently running.

- 1) From the HOME SCREEN, press ENTER to launch the MAIN MENU.
- 2) At the MAIN MENU press ENTER to launch the EMERGENCY STOP menu.
- 3) At the EMERGENCY STOP menu, press ENTER to stop all dispensing and formulas, then press EXIT to return to the MAIN MENU.

6.08 Change Load Weight

For accurate data reporting, the operator should input the actual weight of each load, which overrides the formula's default weight for a single load.

- 1) At the MAIN MENU, move the selection box to the LOAD SIZE menu item and press ENTER. The default load weight will be displayed.
- 2) To change a digit's value press the Up/Down Arrow keys. To move the digit selection cursor, press the Left / Right arrow keys.
- 3) When the proper load weight is displayed, press ENTER save and exit. (Or press EXIT to return to the MAIN MENU without saving).

6.09 User Prime (if enabled)

USER PRIME allows the operator to fill the intake tube after product container or tube change. An animated progress bar will indicate that prime is running.

The operator is expected to stop the prime manually. Dispensing will stop automatically after 10 minutes. If User Prime is set to LIMITED (30 SEC), each product can instead be primed for only 30 seconds and the same product cannot be primed again until a complete formula has run.

- 1) On the MAIN MENU, move the selection box to USER PRIME and press ENTER. The SET PRIME menu will display all available products. (If User Prime is not enabled, the factory default, “DISABLED” will be displayed.)
- 2) Press the Up / Down Arrow keys to choose a product to prime.

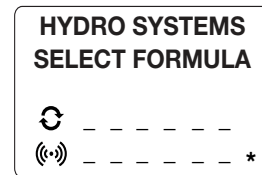

Press Enter key to Launch Main Menu

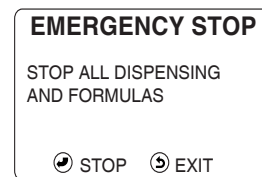
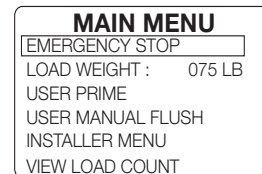

Press Enter key to stop dispensing and cancel current formula.

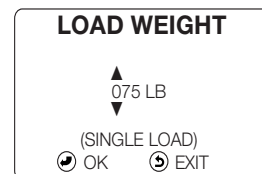

Use Up/Down Arrow keys to edit digit, use Left/Right Arrow keys to move cursor. Press Enter key to save.

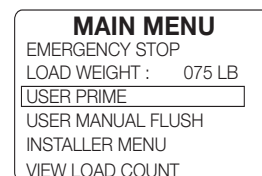

Press Enter to Launch User Prime Menu

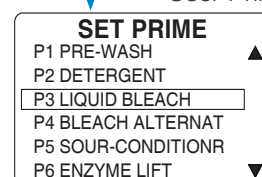

6.00 operator menus (continued)

6.09 User Prime (if enabled) (continued)

- When the selection box is on the desired product, press the Enter key to launch the manual prime menu for that product.
- When in the Prime menu, press the Enter key to start the prime.
- Press the Enter key again to stop the prime.
- Press the Exit once to select another product to prime, or twice to return to the MAIN MENU.

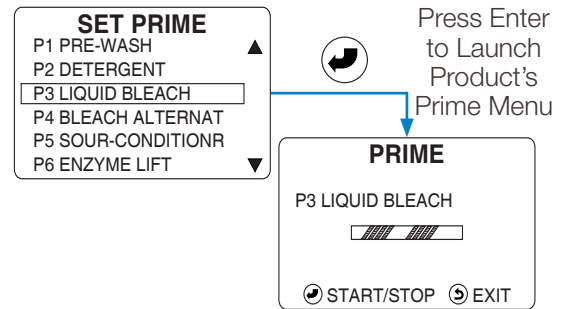

6.10 User Manual Flush (if enabled)

USER MANUAL FLUSH allows the operator to activate the flush manifold solenoid valve and clear the line. A solid black progress bar displays while flush is running. The operator is expected to stop the flush manually, or it will stop automatically after 10 minutes of keyboard inactivity.

In order to use USER MANUAL FLUSH a flush compatible PI must be installed, along with a flush manifold, and the Flush Time must be set to a value greater than zero. (Note: Eductor PI's are flush compatible.) The default Pump Interface setting (see 9.09 "Select Pump Interface" on page 37) is ECLIPSE PI with FLUSH TIME set to 00 = OFF. When the PI or Flush Time settings to not allow flush, "DISABLED" will be displayed.

- On the MAIN MENU, move the selection box to USER MANUAL FLUSH and press ENTER.
- Press the Enter key to start the flush, and press Enter again to stop.
- Press the Exit key to return to the MAIN MENU.

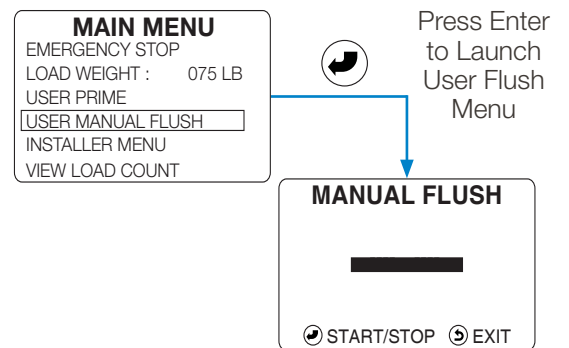

6.11 View Load Count

View Load Count provides the capability to view the number of loads ran for each wash formula since the last time the data log was cleared. (See section 8.13 "Clear Data Log" on page 34 for more details.)

- On the Main Menu move the selection box onto the View Load Count menu item and press the Enter key.
- At the View Load Count menu, use the Up / Down arrow keys to examine the load counts, listed by Formula.
- Select the date range and press Enter to enter a custom date range.

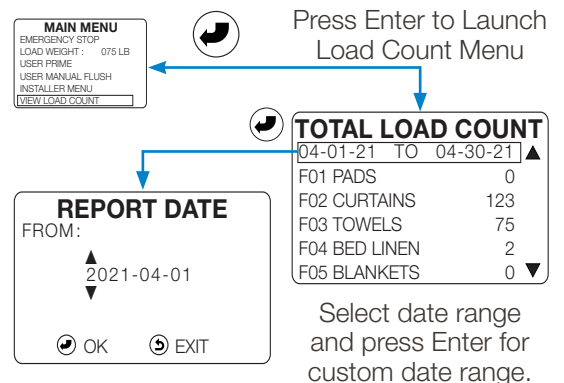

6.12 About Auto Formula Select Operation (AFS)

AFS allows an installer-chosen trigger to select any programmed formula with a timed signal from the washer. That washer supply signal must be programmed for a total of 2 seconds multiplied by the formula number. With AFS set to Trigger 5:

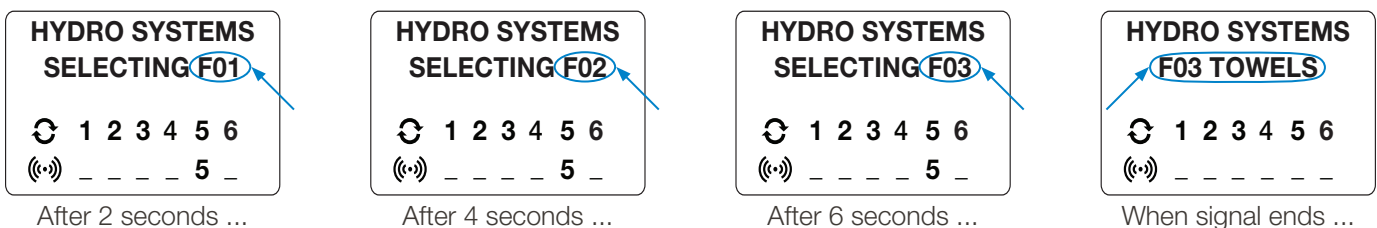

When AFS begins, the controller displays "SELECTING F[##]." Every two seconds, the next formula number [##] displays, until such time as the signal ends, at which point the selected formula is displayed on the Home Screen (e.g. as shown above, if the washer supply signal is set for 6 seconds, F03 TOWELS is selected to run).

NOTE: There is no signal filter qualifying time for AFS signals. (See Section 9.12 "Auto Formula Select" on page 39 for more details.) Also, when running Pump Mapping Mode, trigger 2 is always dedicated to AFS.

7.00 installer menus

7.01 Overview (Service and Settings using Controller Keypad)

Initial system setup and Formula programming can be done using either the controller's Installer Menu and five-button keypad, or the computer-based Formula Editor and transferred to the controller using a USB drive (see section 11.00 on page 45).







 Settings that can ONLY be adjusted by the controller display and keypad are marked in this section with this small icon. Those settings are: **Installer Password**, **Machine Name**, **Company Name** and **Calibration**.

An Installer Password is needed to access the Installer Menu, with its sub-menus, each of which contain additional menus. (See "Installer Menu Tree" on the next page.)

 **WARNING! Entering Installer Menu aborts Formulas!** If the installer Password is input while a formula is running, the formula is aborted and the load is recorded as an incomplete load.

 **NOTE! Installer Menu Timeout!** When in the Installer Menu (and its sub-menus), if there is no keypad activity for 5 minutes, the display will return to the Home Screen and the Installer Password will be required again.

7.02 Key Functions

-  **ENTER:** Used to enter a menu, or accept a value.
-  **EXIT:** Exits the current menu without saving changes, and returns to the previous menu or the Main Menu.
-  **UP/DOWN ARROW:** Changes the value of a selected digit **2** or moves the **Selection Box** up and down.
-  **LEFT/RIGHT ARROW:** Moves the Digit Selection Cursor left and right.
-    ... **(Exit Installer Menus):** Repeatedly press (or press and hold) the Exit key.

7.03 Password Access to Installer Menus

When launching the Installer Menu a password entry is required. The factory default password is "01234". For added security it is strongly recommended that you change the password at installation.

- 1) On the Main Menu move the selection box onto the INSTALLER MENU item and press the Enter key to launch the Installer Menu.
- 2) Enter the Installer Password, using the Up / Down arrow keys to change the selected digit value, and the Left / Right arrow keys to move the Digit Selection Cursor. Press the enter key to input the password.
- 3) A successful password entry will launch the Installer Menus. See the next page for the complete Installer Menu Tree.

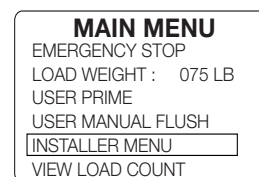

↓  Press Enter to Launch Password Entry Screen



7.04 Minimum Programming Required (Standard Mode)

NOTE: These settings will produce a functioning controller, but will not give accurate reports or enable features.

Standard Mode:

- 1) System Setup > Set PI
- 2) Installer Service > Service Product > Calibrate
- 3) Program Formulas > Select a Formula > Product Settings > Select a Product > Set Dispense Amounts/Delay
- 4) Units of Measure > SAE or Metric

8.00 installer service menus

The INSTALLER SERVICE menu is used during routine maintenance visits.

8.01 Service Products

The SERVICE PRODUCTS menu can be used to prime or calibrate products, typically during the initial setup.

NOTE: A product name only appears with the product number if a name was input or was part of a USB Setup File Transfer.

- 1) In the INSTALLER MENU, move the Selection Box onto the INSTALLER SERVICE menu item and press the Enter key.
- 2) On the INSTALLER SERVICE menu, move the Selection Box over the SERVICE PRODUCTS menu item and press the Enter key.

8.02 Prime

This feature is used to fill or “prime” the intake tube after a product container or tube change. An animated progress bar will indicate when the PRIME function is running.

From the SERVICE PRODUCTS menu, select PRIME and press the Enter key, to launch the SET PRIME menu. The SET PRIME menu displays a list of available products (with names, if previously input or uploaded by the installer).

- 1) Press the Up / Down Arrow keys to select a product to prime.
- 2) Press the Enter key to launch the PRIME screen for the chosen product.
- 3) Press the Enter key to start priming, and an animated progress bar will be displayed.
- 4) Press the Enter key again to stop priming, and the animation will stop.
- 5) Press the Exit key once to select another product to prime, or twice to return to the SERVICE PRODUCTS menu.

8.03 Calibration



You must calibrate all products you will use in a formula, using the method best suited for the system installed. Programmed formulas will not run if products are not calibrated. In Relay Mode, you must calibrate products in order to establish product output.

Choosing a Calibration Method:

TIME: Use when working with large displacement dispensers, such as Hydro’s large laundry peristaltic pumps or double diaphragm air products, when calibrating products with a flush manifold installed or when calibrating eductor laundry dispensers.

VOLUME: Use this method only for medium volume dispensers, like 12-18 oz/min (355-532 ml/min).

MANUAL: Use if you already know the product’s flow rate in oz/min.

View Calibration Settings:

- 1) On the SERVICE PRODUCTS menu, move the selection box onto the CALIBRATION menu item and press the Enter key.
- 2) Move the selection box to VIEW CALIBRATION and press the Enter key to see the current setting for each product.
- 3) Press the Exit key to return to the CALIBRATION screen, then select a calibration method and proceed with calibration.

Service Products

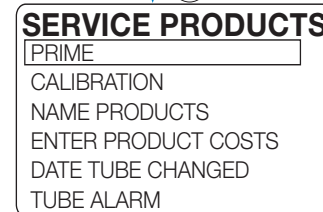
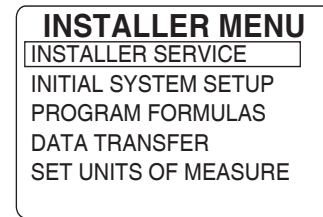

Prime

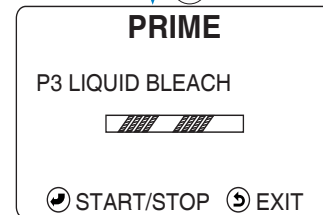
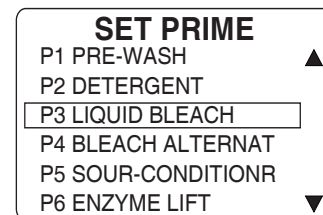

View Calibration

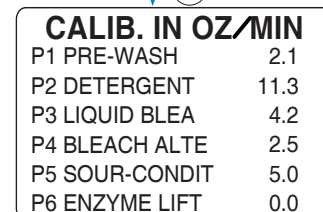
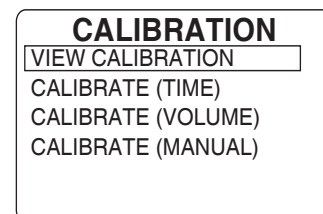

8.00 installer service menus (continued)

8.03 Calibration (continued)

Equipment Needed:

Both time and volume calibration methods require a graduated measuring container to measure the amount of product dispensed.

When calibrating a pump, measure the output of the pump, capturing the product dispensed into the graduated measuring container.

To calibrate an eductor system, measure how much product the chemical intake draws out of the graduated measuring container.

In either case make sure the dispenser intake is primed before starting the timed calibration process. When using the timed method, the measuring container must be able to hold at least the amount of product this system can dispense in 20 seconds.

8.04 Time Calibration

- 1) On the Calibration menu select CALIBRATE (TIME) and press Enter.
- 2) At CALIBRATE (TIME) select a product to calibrate and press Enter.
- 3) Once a product has been selected, the calibration countdown display will appear, with the selected product and its previous 20 second calibration value displayed. Get the measuring container ready, either to collect the output of a pump, or to be drawn out of by an eductor.
- 4) Press Enter to begin dispensing as the countdown begins (with a 2 second delay if flush enabled). Allow the countdown to go to 0.0 at which point the DISPENSED VOLUME display will appear.
- 5) Input the volume of product that was either pumped out or drawn in by an eductor. Then press Enter to complete the product calibration.

8.05 Volume Calibration

- 1) On the Calibration menu select CALIBRATE (VOLUME) and press Enter.
- 2) At CALIBRATE (VOL.) select a product to calibrate and press Enter.
- 3) Once a product has been selected, the volume calibration display will appear, with the selected product indicated. Get the measuring container ready, either to collect the output of a pump, or to draw product out of for an eductor.
- 4) Press Enter to begin dispensing (with a 2 second delay if flush enabled). Press Enter to stop the calibration when 8 oz (250 ml) of product has been pumped into the measuring container or drawn out by an eductor.
- 5) The time required to dispense is automatically calculated, no data input is needed. Use the VIEW CALIBRATION menu to confirm the new value.

8.06 Manual Calibration

- 1) On the Calibration menu select CALIBRATE (MANUAL) and press Enter.
- 2) At MANUAL CALIBRATE select a product to calibrate and press Enter.
- 3) Once the product is selected, the input screen for the manual calibration will appear. Enter the predetermined value in oz/min.

Calibrate by Time

CALIBRATION
VIEW CALIBRATION
CALIBRATE (TIME)
CALIBRATE (VOLUME)
CALIBRATE (MANUAL)



CALIBRATE (TIME)
P1 PRE-WASH
P2 DETERGENT
P3 LIQUID BLEACH
P4 BLEACH ALTERNAT
P5 SOUR-CONDITIONR
P6 ENZYME LIFT



CALIBRATE (TIME)
P2 DETERGENT 3.8
20.0
ALERT! CHECK CONNXNS
TO AVOID SPILLS!
START/STOP EXIT

After 20 seconds

DISPENSED VOLUME
ENTER AMOUNT DISPENSED
▲ 03.77 OZ ▼
OK EXIT

Calibrate by Volume

CALIBRATION
VIEW CALIBRATION
CALIBRATE (TIME)
CALIBRATE (VOLUME)
CALIBRATE (MANUAL)



CALIBRATE (VOL.)
P1 PRE-WASH
P2 DETERGENT
P3 LIQUID BLEACH
P4 BLEACH ALTERNAT
P5 SOUR-CONDITIONR
P6 ENZYME LIFT

Manual Calibration

ENTER VALUE
OZ/MIN
▲ 11.33 OZ ▼
OK EXIT

8.00 installer service menus (continued)

8.07 Name Products (optional)

This allows a name to be added to a product number, "P1 PRE-WASH" for example. The name is not translated if the controller language is changed.

- 1) At the SERVICE PRODUCTS menu, move selection box to NAME PRODUCTS. Press the Enter key to launch SELECT PRODUCT menu.
- 2) Use the Up / Down Arrows to select the product to name (or rename).
- 3) Press Enter to launch the NAME PRODUCT (P#) input screen. The current name (if any) is displayed with the first letter selected for entry.
- 4) Use the Up / Down Arrows to move through letters, numbers, hyphen, underscore and space that can be input for that digit.
- 5) Use the Left / Right arrows to move the digit selection arrows. A maximum of 15 characters can be used for a product name.
- 6) Press the Enter key to save the product name and return to the SELECT PRODUCT menu. Select another product to name, or press the Exit key to return to the SERVICE PRODUCTS menu.

8.08 Enter Product Costs (required for Hydro Connect cost reporting)

Enter the cost (per gallon or liter) for a product, so the cost for the amount dispensed can be calculated in reports. Any currency may be used since the currency type is not considered by the controller. The available digits are 0000.00 (per gallon or liter).

- 1) At the SERVICE PRODUCTS menu, move selection box to INPUT PRODUCT COST. Press Enter to launch PRODUCT COST menu.
- 2) Select a product and press the Enter key. The P# COSTS/GAL (L) input screen will be displayed, where the cost for product can be entered.
- 3) Use the Left / Right arrows to move the digit selection arrows, and use the Up / Down arrows to change the value of a digit, until the correct cost is displayed (per gallon or liter) for this product.
- 4) Press the Enter key to save the cost and return to the PRODUCT COST menu or press the Exit key to cancel the cost value entry.

8.09 Enter Tube Change Date (optional)

For peristaltic pumps only, this menu allows the date a tube is changed to be recorded, for maintenance records or reports.

- 1) At the SERVICE PRODUCTS menu, move selection box to DATE TUBE CHANGED. Press Enter to launch TUBE DATE CHANGE menu.
- 2) Select a product and press the Enter key. The P# TUBE CHANGE input screen will be displayed, where the date of the change can be entered.
- 3) Use the Left / Right arrows to move the digit selection arrows, and use the Up / Down arrows to change the value of a digit, until the desired date is displayed. The current date is the default value (YYYY-MM-DD).
- 4) Press the Enter key to save the date and return to the TUBE DATE CHANGE menu or press the Exit key to cancel the date entry.

Enter Product Name

SERVICE PRODUCTS

PRIME

CALIBRATION
NAME PRODUCTS
ENTER PRODUCT COSTS
DATE TUBE CHANGED
TUBE ALARM



SELECT PRODUCT

P1 PRE-WASH

P2 DETERGENT

P3 LIQUID BLEACH
P4 BLEACH ALTERNAT
P5 SOUR-CONDITIONR
P6 ENZYME LIFT



NAME PRODUCT (P2)

▲
D
▼

OK EXIT

Enter Product Costs

PRODUCT COST

P1 PRE-WASH

P2 DETERGENT

P3 LIQUID BLEACH
P4 BLEACH ALTERNAT
P5 SOUR-CONDITIONR
P6 ENZYME LIFT



P2 COST / GAL

▲
0000.00
▼

OK EXIT

Enter Tube Change Date

TUBE CHANGE DATE

P1 PRE-WASH

P2 DETERGENT

P3 LIQUID BLEACH
P4 BLEACH ALTERNAT
P5 SOUR-CONDITIONR
P6 ENZYME LIFT



P2 TUBE CHANGE

▲
2018-07-28
▼

OK EXIT

8.00 installer service menus (continued)

8.10 Tube Alarm (optional)

This menu is used with the previous Tube Change Date setting to provide a reminder alarm in the Hydro Connect service for when to change the squeeze tube for peristaltic pumps.

When the date equal to the Tube Change Date plus the number of days configured is reached, the alarm will be triggered in Hydro Connect.

- 1) At the SERVICE PRODUCTS menu, move the selection box to TUBE ALARM, and press Enter to launch TUBE ALARM menu.
- 2) Use the Up / Down arrows to Select the number of days after the TUBE DATE CHANGE and press the Enter key. If 0 days are entered, the alarm will be disabled.

(The three sets of double-arrow cursors indicate that all digits will increase or decrease at the same time.)

Enter Tube Alarm Duration

SERVICE PRODUCTS
PRIME
CALIBRATION
NAME PRODUCTS
ENTER PRODUCT COSTS
DATE TUBE CHANGED
TUBE ALARM



TUBE ALARM

▲▲▲
365 DAY
▼▼▼

(0 = OFF)

8.11 View Load Weight

This menu displays the total weight washed, by formula, since the last time the data log was cleared (see 8.17 “Clear Data Log” below).

- 1) On the INSTALLER MENU menu, move the selection box onto the INSTALLER SERVICE menu item and press the Enter key.
- 2) Put the selection box on VIEW LOAD WEIGHT and press the Enter key.
- 3) The TOTAL WEIGHT menu will display the total weight washed by formula.
- 4) Use the Up / Down Arrows to view all formulas.
- 5) Press the Exit key to return to the INSTALLER SERVICE menu.

View Load Weight

INSTALLER SERVICE
SERVICE PRODUCTS
VIEW LOAD WEIGHT
VIEW AMT DISPENSED
CLEAR DATA LOG



TOTAL WEIGHT
F01 PADS 0
F02 CURTAINS 150
F03 TOWELS 375
F04 BED LINEN 600
F05 BLANKETS 300
F06 TABLE LINEN 100 ▼

8.12 View Amount Dispensed

This menu displays the amount of each product that has been dispensed (in gallons of liters) since the last time the data log was cleared (see 8.17 “Clear Data Log” below).

- 1) On the INSTALLER MENU menu, move the selection box onto the INSTALLER SERVICE menu item and press the Enter key.
- 2) Move the selection box onto VIEW AMT DISPENSED and press the Enter key.
- 3) The DISPENSED (GAL)/(L) menu will display the amount dispensed of each product.
- 4) If necessary, use the Up / Down Arrows to view all products.
- 5) Press the Exit key to return to the INSTALLER SERVICE menu.

View Amount Dispensed

INSTALLER SERVICE
SERVICE PRODUCTS
VIEW LOAD WEIGHT
VIEW AMT DISPENSED
CLEAR DATA LOG



DISPENSED (GAL)
P1 PRE-WASH 1.1
P2 DETERGENT 23.5
P3 LIQUID BLEA 7.1
P4 BLEACH ALTE 12.0
P5 SOUR-CONDIT 6.8
P6 ENZYME LIFT 0.4 ▼

8.00 installer service menus (continued)

8.13 Clear Data Log

The ZERO DATA LOG function re-sets all counters to zero (0), including the Load Count, Load Weight, and Amount Dispensed to. Control settings & Formulas are not affected by this function.

- 1) On the INSTALLER MENU menu, move the selection box onto the CLEAR DATA LOG menu item and press the Enter key.
- 2) The “Zero Data Log” screen will appear, with which all data logs can be cleared.

CAUTION! All logged data for load weight, total loads run, and product amounts will be reset to zero.

- 3) Press the Enter key to indicate it is “OK” to clear all data logged and reset counters to zero. Or press the Exit key to cancel this function.

NOTE: Past information for Manager Reports, Summary Reports, and the Activity Log is no longer available when the Data Log is cleared.

Also, when the Data Log reaches the point where it is completely filled, any new info that is recorded will overwrite the oldest record. It is recommended that required reports be run at least every 30-60 days to avoid loss of information.

Clear (Reset) Data Logs

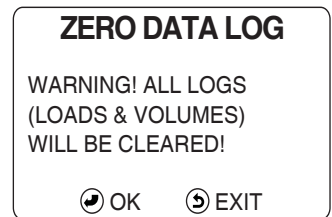
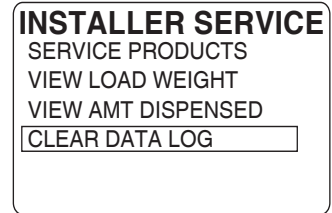

Section 9.00 “Initial System Setup Menus” starts on the next page.

9.00 initial system setup menus

9.01 Edit Installer Password

The Installer Password may be changed from the factory default (01234) to any five-number password.

WARNING! Be sure to note any new Installer Password. If the password is lost, the Installer Menus will be inaccessible and the controller will have to be returned to Hydro Systems and reprogrammed to factory defaults.

- 1) On the INSTALLER MENU menu, move the selection box onto the INITIAL SYSTEM SETUP menu item and press the Enter key.
- 2) At the SYSTEM SETUP menu, put the selection box on the EDIT INST PASSWORD menu item and press the Enter key.
- 3) The INSTL PASSWORD menu will display the current password, and a new password can be defined
- 4) Use the Up / Down Arrows to change a digit's value and use the Left / Right arrows to move the Digit Selection Cursor.
- 5) Press the Enter key to save a new password and return to the SYSTEM SETUP menu. Or press the Exit key to cancel the password edit.

Edit Installer Password

SYSTEM SETUP
EDIT INST PASSWORD ▲
OPERATION MODE
EDIT NODE ADDRESS
EDIT ACCOUNT NAME
EDIT MACHINE NAME
EDIT COMPANY NAME ▼

↓ ↻

INSTL PASSWORD
▲
0 1 2 3 4
▼
⏹ OK ⏹ EXIT

9.02 Set Operation Mode

Each operation mode has a different combination of rules that govern the dispensing sequence. To understand these rules, see “Modes of Operation” on page 11 and also “Features and Options” on page 12.

9.03 Set Operation Mode to Standard

Standard Mode is the default mode (and used in most North American installations). Each washer trigger signal notifies the corresponding product to dispense the amount(s) based on the selected formula.

Standard Mode also features AFS, explained in “About Auto Formula Select (AFS)” on page 27.

- 1) At the SYSTEM SETUP menu, put the selection box on the OPERATION MODE menu item and press the Enter key.
- 2) When the OPERATION MODE menu appears, move the selection box onto the STANDARD menu item and press the Enter key to select that operation mode and return to the SYSTEM SETUP menu, or press the Exit key to cancel the operation mode selection.

Set Operation Mode to Standard

SYSTEM SETUP
EDIT INST PASSWORD ▲
OPERATION MODE
EDIT NODE ADDRESS
EDIT ACCOUNT NAME
EDIT MACHINE NAME
EDIT COMPANY NAME ▼

↓ ↻

OPERATION MODE
STANDARD
PUMP MAPPING

9.04 Set Operation Mode to Pump Mapping

Pump Mapping Mode is used in most European installations. In this mode, the six trigger signals are assigned to four, predefined wash steps (see table on right).

Between 0-3 products may be assigned to each wash step. A product may be used in more than one step. The trigger signals determine which wash step will dispense their programmed formula amounts, and in what order.

All product amounts and delays are based upon the currently selected formula. If a trigger for a product to run occurs and the product is already running, the trigger is ignored.

Pump Mapping Trigger Assignments

Wash Step	Trigger Signal Inputs
Prewash	Trigger 1
AFS	Trigger 2
Mainwash (2H/2C)	Trigger 3 and/or 4
Spare	Trigger 5
Final Rinse	Trigger 6

9.00 initial system setup menus (continued)

9.04 Set Operation Mode to Pump Mapping (continued)

The installer **MUST** allow enough time between triggers to ensure a product (or group of products) can run for each of its triggers.

Also, if a product is included in a wash step, but is not in the currently selected formula, the product will not run when triggered. This could result in not running some or all of the products called for by a trigger signal.

- 1) At the SYSTEM SETUP menu, put the selection box on the OPERATION MODE menu item and press the Enter key.
- 2) When the OPERATION MODE menu appears, move the selection box onto the PUMP MAPPING menu item and press the Enter key to select that operation mode and launch the PUMP MAPPING menu, or press the Exit key to cancel the operation mode selection.

Set Wash Step (Add Products to a Wash Step):

- 1) After Selecting PUMP MAPPING in the previous step, select the Wash Step / Event you want to add products to and press the Enter key to launch the E# PROD SELECT menu.
- 2) Any products selected to dispense from a previous set up will already have a check mark to the right of the product identifier.

Use the Up / Down Arrows to move the selection box among the products and press the Enter key to select or deselect products.

- 3) Up to three products can be selected for any wash step. Trying to select more than three products for a wash step will generate an error display.
- 4) When all the desired products have been selected for this wash step press the Exit key to return to the previous menu where another wash step may be selected for configuration.

- 5) When all products needed have been assigned to their groups, press the Exit key repeatedly to return to the SYSTEM SETUP menu.

9.05 Edit Address

For each Connected Total Eclipse Controller that is connected to the gateway (up to four), a unique Address must be assigned. If a gateway is not used, this field can be ignored,

The address is a number from 1-4 that helps Hydro Connect keep track of the data streaming from each controller.

- 1) At the SYSTEM SETUP menu, put the selection box on the EDIT ADDRESS menu item and press the Enter key.
- 2) Use the Up / Down Arrows to set the correct address.

Please make sure that each Connected Total Eclipse Controller that is connected to the gateway has a unique address set.

- 3) Press the Enter key to save the address and return to the SYSTEM SETUP menu or press the Exit key to cancel addressing.

Set Operation Mode to Pump Mapping

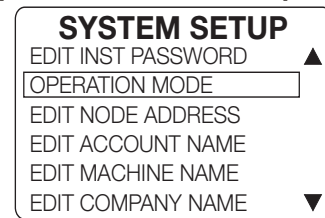

SYSTEM SETUP
EDIT INST PASSWORD ▲
OPERATION MODE
EDIT NODE ADDRESS
EDIT ACCOUNT NAME
EDIT MACHINE NAME
EDIT COMPANY NAME ▼

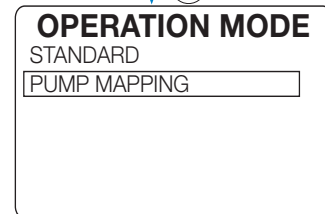

OPERATION MODE
STANDARD
PUMP MAPPING

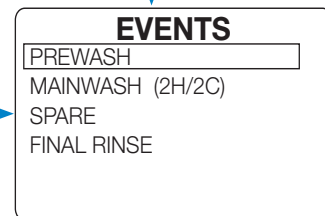

EVENTS
PREWASH
MAINWASH (2H/2C)
SPARE
FINAL RINSE

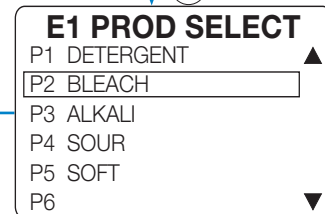

E1 PROD SELECT
P1 DETERGENT ▲
P2 BLEACH
P3 ALKALI
P4 SOUR
P5 SOFT
P6 ▼



Up to 3 Products may be selected for each Wash Step / Event.



ERROR
3 PRODUCTS MAXIMUM
OK EXIT

Edit Address

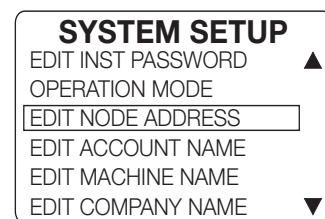

SYSTEM SETUP
EDIT INST PASSWORD ▲
OPERATION MODE
EDIT NODE ADDRESS
EDIT ACCOUNT NAME
EDIT MACHINE NAME
EDIT COMPANY NAME ▼

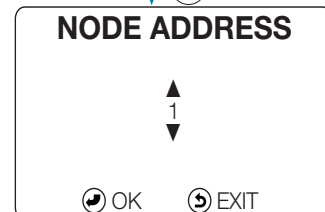

NODE ADDRESS
▲
1
▼
OK EXIT

9.00 initial system setup menus (continued)

9.06 Edit Account Name (optional)



For the input of a client or account name that appears on reports. The name can use capital A-Z, 0-9, underscore, hyphen or space.

- 1) In the SYSTEM SETUP menu move the selection box to the EDIT ACCOUNT NAME menu item and press the Enter key to launch the ACCOUNT NAME input screen. The current name (if any) is displayed with the first letter selected for entry.
- 2) Use the Up / Down Arrows to move through the capital letters, numbers, hyphen, underscore and space that can be input for that digit.
- 3) Use the Left / Right arrows to move the digit selection cursor. A maximum of 15 characters can be used for the account name.
- 4) Press the Enter key to save the account name and return to the SYSTEM SETUP menu or press the Exit key to cancel account naming.

9.07 Edit Machine Name (optional)



To input a name for the washing machine that appears on reports. The name can use capital A-Z, 0-9, underscore, hyphen or space.

Follow the same procedure as in 9.09 above, except for launching the EDIT MACHINE NAME menu on the SYSTEM SETUP menu.

9.08 Edit Company Name (optional)



To input the chemical company's name that appears on the Home Screen. The name can use capital A-Z, 0-9, underscore, hyphen or space.

Follow the same procedure as in 9.09 above, except for launching the EDIT COMPANY NAME menu on the SYSTEM SETUP menu.

9.09 Select Pump Interface

NOTE! "Pump Interface" (PI) is a generic term for the printed circuit board inside a product dispenser that receives signals from the controller and operates the pump motors or eductor solenoids. Each pumpstand or eductor dispenser has a unique PI board. The following illustrations may help to identify the PI board.

Eclipse 6 Product
Menu Name:
"Eclipse Flush PI"

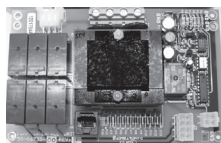

Large Laundry 6 Product
Menu Name:
"Orion II Flush PI"

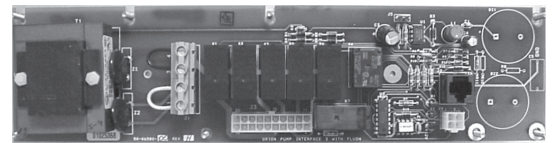

Eductor 6 Product
Menu Name:
"6-Eductor Flush PI"

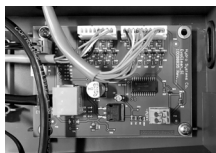

Large Laundry 8 Product
Menu Name:
"8-Product Flush PI"



The Connected Total Eclipse controller only controls flush when used with a flush-compatible Hydro Pump Interface (PI) board. These boards can be used with or without a flush manifold, while an eductor dispenser has a flush manifold built in.

When flush mode is enabled, only one product may run at a time, and if multiple products are triggered simultaneously, they are placed in a queue to run sequentially.

Edit Account Name

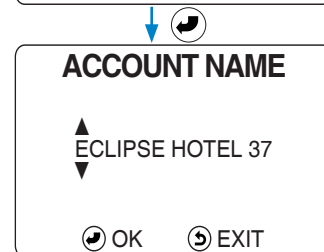
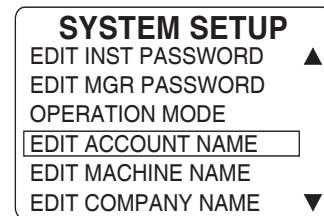

Edit Machine Name

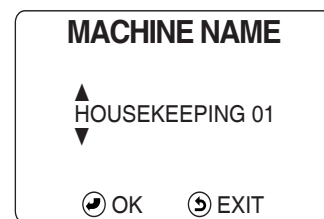

Edit Company Name

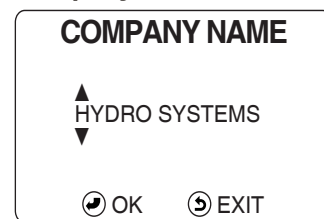

9.00 initial system setup menus (continued)

9.09 Select Pump Interface (continued)



NOTE! It is important to select the correct Pump Interface (corresponding to the dispenser) to ensure proper and safe operation.

A confirmation warning message (shown to the right) will appear whenever an eductor PI is selected, or if a controller configured for eductors is connected to a peristaltic pump dispenser.

The appropriate Pump Interface for this installation must be selected so the proper control signals are sent to correctly dispense products. See “Selecting the Pump Interface” on the previous page for details.

- 1) At the SYSTEM SETUP menu, move the selection box down until the menu scrolls up, and onto the SET DISPENSER INTF menu item and press the Enter key.
- 2) On the SET DISPENSER INTF menu, move the selection box to the Pump Interface (PI) that corresponds to the dispenser being used and press Enter. The factory default selection is “ECLIPSE FLUSH P.I”.

9.10 Set Flush Time (Enable Flush Operation)

- 1) When a flush compatible PI board is selected, the FLUSH TIME menu will launch, for setting the flush time after dispensing, in seconds. Also see “Flush Operation ...” on page 12. All flush compatible PI boards will default to 10 seconds. Eductor flush can be set from 10 to 99 seconds. For peristaltic installations where a flush manifold is NOT installed, the Flush Time can be set to zero to disable flush. **A flush time MUST be used with any flush manifold, to avoid hazardous chemical mixing!** With flush enabled there will always be a fixed 2-second pre-flush before dispensing, as well as the post-flush using this Flush Time setting, up to 99 seconds.
- 2) Use the Up / Down Arrows to move through the values 0 to 9, and use the Left / Right arrows to move the digit selection cursor.
- 3) Press Enter to save the Flush Time value and return to the DISPENSER INTF menu or press Exit to cancel the Flush Time input.



NOTE! The Connected Total Eclipse controller only controls flush with a flush-compatible PI board. With flush mode enabled, only one product may run at a time. If multiple products are triggered simultaneously, they are queued to run sequentially.

9.11 Set Signal Filter Time

The Signal Filter Time is the amount of time a trigger signal needs to be on continuously before the controller will accept the signal as valid. Only when a trigger has been on as long as the setting (2 seconds is the default) is the signal considered “qualified” (a true signal). Use a longer filter time if a washer produces unreliable signals that falsely triggers products. This one filter time setting is used for all trigger signals, except an AFS trigger.

- 1) At the SYSTEM SETUP menu, move the selection box down until the menu scrolls up, and onto the SIGNAL FILTER TIME menu item and press the Enter key to launch the TRIGGER FILTER selection menu.
- 2) On the TRIGGER FILTER menu, use the Up / Down Arrows to move the selection box onto the desired signal filter time and press the Enter key to select that setting, or press the Exit key to cancel the selection.

Eductor PI Selection Confirmation

WARNING

EDUCTOR P.I SELECTED
ARE YOU SURE THAT AN
EDUCTOR DISPENSER IS
CONNECTED?

⏪ OK ⏩ EXIT

Select Pump Interface

SYSTEM SETUP

EDIT NODE ADDRESS ▲

EDIT ACCOUNT NAME

EDIT MACHINE NAME

EDIT COMPANY NAME

SET DISPENSER INTF

SIGNAL FILTER TIME ▼



DISPENSER INTF

NON-FLUSH P.I. ▲

ECLIPSE FLUSH P. I.

ORION II FLUSH P. I.

8-PUMP FLUSH P. I.

4-EDUCTOR FLUSH P. I

6-EDUCTOR FLUSH P. I ▼



FLUSH TIME

▲
10 SEC
▼

(0 = OFF)

⏪ OK ⏩ EXIT

Set Signal Filter Time

SYSTEM SETUP

EDIT NODE ADDRESS ▲

EDIT ACCOUNT NAME

EDIT MACHINE NAME

EDIT COMPANY NAME

SET DISPENSER INTF

SIGNAL FILTER TIME ▼



TRIGGER FILTER

2 SECONDS

10 SECONDS

20 SECONDS

30 SECONDS

60 SECONDS

90 SECONDS

9.00 initial system setup menus (continued)

9.12 Set [AFS] Auto-Formula Select Trigger

The AFS feature of the Standard operation mode allows a timed trigger signal from the washer to automatically select and run any programmed formula. The Trigger Filter Time is not used on an AFS signal. The default trigger setting for the AFS trigger is 0 (Off).

NOTE! To avoid confusion do not to use a trigger signal that starts or ends a formula for AFS. (The first product triggered starts a formula and the Count Pump ends the formula.) See 2.01 “Auto Formula Select (AFS)” on page 12 for more information.

To use an AFS trigger the installer must program the corresponding washer supply signal to energize for a total of 2 seconds multiplied by the desired formula number. For example:

- a 2 second signal = Formula 1 (2 x 1 = 2)
- a 4 second signal = Formula 2 (2 x 2 = 4)
- a 6 second signal = Formula 3 (2 x 3 = 6), and so forth.

- 1) At the SYSTEM SETUP menu, move the selection box down until the menu scrolls up, and onto the SET AFS TRIGGER menu item and press the Enter key to launch the AFS TRIGGER menu.
- 2) On the AFS TRIGGER menu, use the Up / Down Arrows to indicate the desired AFS trigger (0-6) and press the Enter key to save that setting.

NOTE! In Pump Mapping Mode, trigger 2 is always dedicated for AFS. To use AFS with Pump Mapping, simply enable it in the System Setup Menu.

9.13 Set User Prime

The User Prime feature (when enabled) allows the machine operator to prime products without needing a password. By default User Prime is disabled. The ENABLE choice will allow the operator to determine the length of time prime will run (up to 5 minutes), while the LIMITED 30 SEC choice will limit the User Prime to 30 seconds per product, per wash cycle.

- 1) At the SYSTEM SETUP menu, move the selection box down until the menu scrolls up, and onto the SET USER PRIME menu item and press the Enter key to launch the USER PRIME configuration menu.
- 2) Use the Up / Down Arrows to move the selection box to one of the three options: DISABLE, ENABLE or LIMITED 30 SEC.
- 3) Press Enter to save the configuration and return to the SYSTEM SETUP menu or press the Exit key to cancel the USER PRIME configuration.

9.14 Set LCD Contrast

The contrast on the controller’s display screen can be adjusted to adapt to the environment and the viewing needs of the user. The default setting is 60; the range is 30 (light) - 99 (dark). The two, double-arrow cursors $\blacktriangle\blacktriangle$ indicate that both digits will increase or decrease at the same time.

- 1) On the SYSTEM SETUP menu, move the selection box down until the menu scrolls up, and onto the SET LCD CONTRAST menu item and press the Enter key to launch the LCD CONTRAST adjustment menu.
- 2) At the LCD CONTRAST menu, use the Up / Down Arrows to adjust the display contrast. A higher value will increase contrast (darken the screen) and a lower value will reduce contrast (lighten the screen).
- 3) Press the Enter key to save the contrast adjustment and return to the SYSTEM SETUP, or press the Exit key to cancel the adjustment.

Set / Enable AFS Trigger Signal

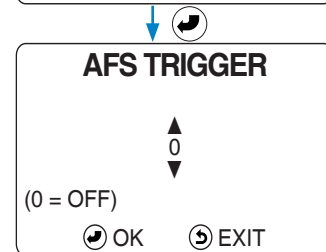
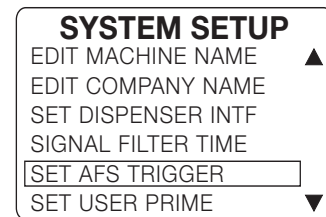

NOTE! Setting the AFS Trigger Signal to any non-zero value automatically enables the Auto-Formula Select feature. A setting of zero (0) will disable Auto-Formula Select.

Set User Prime

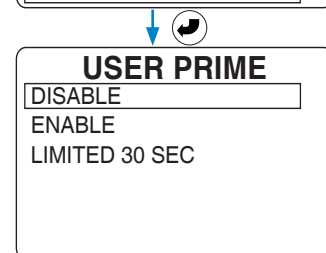
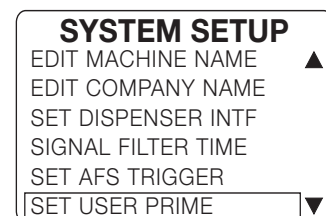

Set LCD Contrast

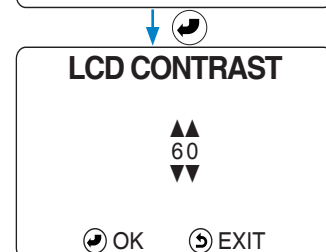
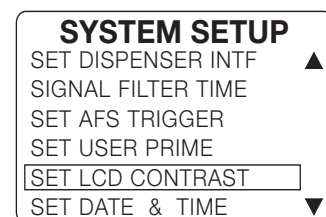

9.00 initial system setup menus (continued)

9.15 Set Date & Time

This menu allows the date and time to be set, as needed. Keep the date and time correct, as they are important for creating accurate reports! For instructions on changing the date or time, see section 4.03 “Setting Date, Time and Time Zone” on page 19. These settings are retained if the power is turned off.

9.16 Set Time Zone

This menu allows the local time zone to be set, as needed. Keep the time zone correct, as it is important for creating accurate reports in Hydro Connect. For instructions on changing the time zone, see section 4.03 “Setting Date, Time and Time Zone” on page 19. This setting is retained if the power is turned off.

9.17 Clear Settings to Factory Defaults

Clears all controller settings (passwords, mode of operation, formulas, trigger assignments, flush, etc.) and restores the controller to the factory default setting.

NOTE! Once CLEAR SETTINGS has been performed, it cannot be undone.

The Date & Time settings are not affected by this function.

- 1) At the SYSTEM SETUP menu, move the selection box down until the menu scrolls up, and onto the CLEAR SETTINGS menu item and press the Enter key to launch the CLEAR SETTINGS menu.
- 2) The first of two warnings will be displayed. Using this function will erase all controller settings (passwords, mode of operation, formulas, trigger assignments, flush, etc.) and restore the controller to the factory default settings. To continue press the Enter key or press the Exit key to cancel.
- 3) The second warning will be displayed to ask “**ARE YOU SURE?**” Once the CLEAR SETTINGS has been performed, it cannot be undone! To continue press the Enter key or press the Exit key to cancel.

9.18 View Software ID

For diagnostic or troubleshooting purposes, Hydro Systems’ Technical Support personnel may need to know the software ID for a particular Connected Total Eclipse controller. This is also how to check if the software is up to date.

- 1) At the SYSTEM SETUP menu, move the selection box down until the menu scrolls up, and onto the VIEW SOFTWARE ID menu item and press the Enter key to launch the VIEW SOFTWARE ID display.
- 2) The Hydro Systems part number for the software installed in the Connected Total Eclipse controller will be displayed, along with the revision number of that software version.
- 3) Press any key to return to the SYSTEM SETUP menu.

Set Time & Date

DATE & TIME

▲
2021-07-28 17:06
▼

YYYY-MM-DD HH:MM

⏪ OK ⏩ EXIT

Set Time Zone

TIME ZONE

EST Eastern NA ▲

CST Central NA

MST Mountain NA

PST Pacific NA

GMT Western EU

CET Central EU ▼

Reset to Factory Defaults

SYSTEM SETUP

SET AFS TRIGGER ▲

SET USER PRIME

SET LCD CONTRAST

SET DATE & TIME

SET TIME ZONE

CLEAR SETTINGS ▼



CLEAR SETTINGS

WARNING! ALL SETUPS
WILL BE CLEARED TO
FACTORY DEFAULTS!

⏪ OK ⏩ EXIT



CLEAR SETTINGS

ARE YOU SURE?

⏪ OK ⏩ EXIT

View Software ID

SYSTEM SETUP

SET USER PRIME ▲

SET LCD CONTRAST

SET DATE & TIME

SET TIME ZONE

CLEAR SETTINGS

VIEW SOFTWARE ID ▼



VIEW SOFTWARE ID

TOTAL ECLISPE
P/N: 95-09114-07
REV: 284

10.00 programming

About Programming Formulas:

The PROGRAM FORMULAS menu allows the installer to create and edit formulas for the Standard and Pump Mapping Modes. See section 9.02 “Set Operation Mode” on page 35 for explanations of each mode of operation.

The Connected Total Eclipse controller allows up to 48 formulas to be created, each using up to 8 products.

- Each formula is designated by a unique formula number (F01, F02, F03...).
- For ease of selection, a name can be used with a formula number. (See section 10.07 “Edit Name (Optional)” on page 44.)
- Formula names only appear when input by the installer or uploaded from a setup file on a USB flash drive.
- Formula names are not translated if the controller’s operating language is changed.
- Each formula can include up to 6 products when using a 6-product dispenser, or 8 products with an 8-product dispenser.
- Each product in a formula may be programmed for up to 3 amounts (A, B, and C Amount).
- A delay time may be programmed for any product in any formula.
- A product can be included in more than one formula, with different A, B, and C Amounts and a different delay.
- Each possible product is also given a unique product number (P1, P2, P3...).
- For ease of selection, a name can be added to the product number. (See 8.07 “Name Products (Optional)” on page 32.)
- Product names only appear when input by the installer or uploaded from a setup file on a USB flash drive.
- Product names are not translated if the controller’s operating language is changed.
- Each product in a formula must be calibrated before running the formula (See section 8.03 “Calibration” on page 30.)

About the “Count Pump”:

A load is counted when the “Count Pump” product dispenses its last programmed amount. By default the “Count Pump” will be assigned to the highest numbered product (with an amount programmed) in each formula. Which will work if that product is always the last product to be dispensed.

Instead, it is recommended that the “Count Pump” designation always be manually assigned by the installer to the last product dispensed in each formula, rather than relying on the “highest numbered” default rule. Also, if a product assigned as the “Count Pump” has more than one amount programmed, the load will not be counted unless the last amount is dispensed.

10.01 Formula Rules

In both Standard and Pump Mapping Modes a product may be programmed to dispense multiple times, with up to three different amounts (identified as Amount A, B and C). A product will not dispense unless at least one non-zero amount is set for that product in the formula.

Standard Mode:

If only the A amount is programmed for a product in a formula, the first request results in Amount A dispensing. Additional requests within the same wash cycle are ignored. If only A and B amounts are programmed for a product in a formula, the first request results in the dispensing of Amount A. The second request results in the dispensing of Amount B. Additional requests (after the second request) are ignored.

If all three amounts (A, B, and C) are programmed for a product in a formula, the first request results in the dispensing of Amount A. The second request results in the dispensing of Amount B and the third request results in the dispensing of Amount C. Each additional request (after the third request) results in the dispensing of Amount C again.

These dispensing sequences are reset when the wash cycle ends. This occurs when the Count Pump’s highest amount has been dispensed and any programmed end of load offset time has expired.

Pump Mapping Mode:

In Pump Mapping Mode, pumps that are allocated to Prewash (Trigger 1) will only dispense the A amount. Amounts entered for B and C amounts will be ignored.

Pumps allocated to the Mainwash (Trigger 3 and 4) will dispense the B amount on the first trigger and the C amount on the second trigger. Amounts entered for A will be ignored.

Pumps allocated to the Spare (Trigger 5) and the Final Rinse (Trigger 6) will dispense the A amount on the first trigger, followed by the B amount on the second, and finally the C amount on the third trigger. The dispensing sequence is reset when the wash cycle ends.

10.00 programming (continued)



WARNING! It is imperative that when the installer is programming the washer signals, to allow plenty of time between triggers to ensure that a product (or group of products) will run for each of its triggers.

Programming Notes:

- Only program the product amounts that will actually be triggered by the washer supply signals.
- Program A, B, and C amounts for different product amounts within a wash formula, or use the amounts as a lockout by not programming any B or C amount.
- With an 8-product PI products 7 and 8 share the same trigger signals (respectively) as products 3 and 5. By programming alternating A, B and/or C amounts for product 3 and 7 (or 5 and 8) up to 8 products can be dispensed with only 6 signals.
- When using a flush manifold only one product may run at a time, and if multiple products are triggered simultaneously, they are placed in a queue to run sequentially

10.02 Program Formulas Menu

- 1) On the INSTALLER MENU menu, move the selection box onto the PROGRAM FORMULAS menu item and press the Enter key to launch the PROGRAM FORMULAS menu.
- 2) On the PROGRAM FORMULAS menu, use the Up / Down Arrows to indicate the formula to be configured and press the Enter key to launch the F## <formula name> menu.

10.03 Product Settings

- 1) At the F## <formula name> menu, move the selection box onto the PRODUCT SETTINGS menu item and press the Enter key to launch the F## PRODUCTS menu.
- 2) On the F## PRODUCTS menu, use the Up / Down Arrows to indicate the first product to be added to the formula and press Enter to launch the F## P# menu for that product. (F## is the Formula, P# is a Product.)
- 3) On the F## P# menu move the selection box onto the product parameter to configure and press the Enter key to launch the input screen for that value.
- 4) The F## P# DELAY input screen is where to input a value to delay the dispensing of any of the programmed amount by 0 to 999 seconds.
- 5) The F## P#A AMOUNT input screen is where to designate how much product will be dispensed by the first trigger signal, in ounces or ml.
- 6) The F## P#B AMOUNT input screen is where to designate how much product will be dispensed by the second trigger signal, in ounces or ml.
- 7) The F## P#C AMOUNT input screen is where to designate how much product will be dispensed by the second trigger signal, in ounces or ml.
- 8) The Right Arrow can be used to test a product delivery amount when the selection box is on a product amount menu item (not the Delay).
- 9) Once this product delivery has been configured press Exit to return to the F## PRODUCTS menu to select another product for this formula.

Set Product Amounts and Delay

INSTALLER MENU

INSTALLER SERVICE

INIIAL SYSTEM SETUP

PROGRAM FORMULAS

DATA TRANSFER

SET UNITS OF MEASURE



PROGRAM FORMULAS

F01 PADS

F02 CURTAINS

F03 TOWELS

F04 BED LINEN

F05 BLANKETS

F06 TABLE LINEN



F01 PADS

PRODUCT SETTINGS

SET DEFAULT WEIGHT

SET COUNT PUMP

SET END TIME OFFSET

EDIT NAME

CLEAR FORMULA



F01 PRODUCTS

P1 PRE-WASH

P2 DETERGENT

P3 LIQUID BLEACH

P4 BLEACH ALTERNAT

P5 SOUR-CONDITIONR

P6 ENZYME LIFT



F01 P1

P1 DELAY 000 SEC

P1A AMOUNT 08.00 OZ

P1B AMOUNT 00.00 OZ

P1C AMOUNT 00.00 OZ

▶ TO TEST

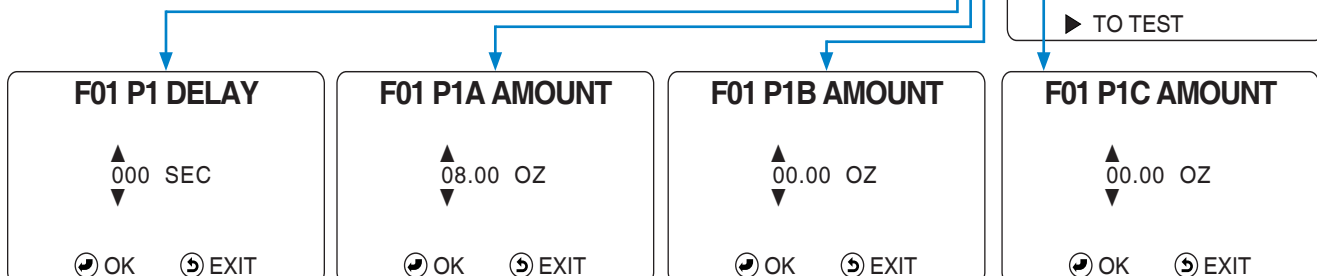

10.00 programming (continued)

10.04 Set Default Weight

Here the **default** load weight for this formula can be input.

When a load runs, either the default load weight or the operator-entered actual load weight for a specific load is recorded in the data log (for Reports).

- 1) Move the selection box onto the SET DEFAULT WEIGHT menu item and press the Enter key to launch the F## LOAD WEIGHT input screen.
- 2) Change the active digit by pressing the Up / Down Arrow keys. Move the digit selection cursor with the Left / Right Arrow keys.
- 3) When the desired load size has been input, press the Enter key to save the weight and return to F## <formula name> menu.

10.05 Set Count Pump

An installer should ALWAYS designate a Count Pump to indicate the end of a wash cycle, overriding the default automatic selection of the highest *numbered* product in a formula. (The traditional term “Count Pump” is still used, even when dispensing products with an educator dispenser.)

NOTE! Only when the *last* programmed amount for the Count Pump product is dispensed, will the Count Pump feature end the wash cycle and reset the formula! Therefore, the installer must ensure that at least one amount is programmed for the Count Pump product AND that the last programmed amount is dispensed! (Or the cycle will be recorded as an “incomplete load” and the Load Count statistical data will be incorrect.)

- 1) Select SET COUNT PUMP and press Enter key. The F## COUNT PUMP selection screen displays all products with at least one amount set.
- 2) Move the selection box to the Count Pump product, and press Enter key to save the selection and return to the F## <formula name> screen.

10.06 Set End Time Offset (optional)

Setting an end time offset can be useful in some scenarios to make the Hydro Connect reporting more accurate.

This value will offset the end time recorded in Hydro Connect for a given formula in the event that there is an operation **after** the count pump runs, like a long extract process for example.

- 1) Select SET END TIME OFFSET and press Enter key. The F## END OFFSET adjustment screen will be displayed.
- 2) Adjust the offset time (0-20 minutes) using the Up / Down Arrow keys. The two sets of double-arrow cursors indicate that all digits will increase or decrease at the same time.
- 3) When the proper time is selected, press the Enter key to save the selection and return to the F## <formula name> screen.

Set Default Weight

F01 PADS
PRODUCT SETTINGS
SET DEFAULT WEIGHT
SET COUNT PUMP
SET END TIME OFFSET
EDIT NAME
CLEAR FORMULA



F01 LOAD WEIGHT
▲ 000 LB ▼
OK EXIT

Set Count Pump

F01 PADS
PRODUCT SETTINGS
SET DEFAULT WEIGHT
SET COUNT PUMP
SET END TIME OFFSET
EDIT NAME
CLEAR FORMULA



F01 COUNT PUMP
P1 PRE-WASH
P2 DETERGENT
P4 BLEACH ALTERNAT
P5 SOUR-CONDITIONR

Set End Time Offset

F01 PADS
PRODUCT SETTINGS
SET DEFAULT WEIGHT
SET COUNT PUMP
SET END TIME OFFSET
EDIT NAME
CLEAR FORMULA



F01 END OFFSET
▲▲ 00 MIN ▼▼
OK EXIT

10.00 programming (continued)

10.07 Edit Name (Optional)

This feature allows a customized name to be added to a formula, up to 15 characters in length.

- 1) Move the selection box onto the EDIT NAME menu item and press the Enter key to launch the NAME F## input screen.
- 2) Change the active digit by pressing the Up / Down Arrow keys. Move the digit selection cursor with the Left / Right Arrow keys.
- 3) When the desired formula name has been input, press the Enter key to save the new customized name and return to F## <formula name> menu.

10.08 Clear Formula

Use this menu **only** if you want to completely clear a formula's settings.

This option will revert all the formula's settings to their **factory default** values.

- 1) Move the selection box onto the CLEAR FORMULA menu item and press the Enter key to launch the CLEAR F## confirmation screen.
- 2) Press the Enter key to indicate it is OK to completely clear this formula's settings, or press the Exit key to cancel the CLEAR FORMULA function.
- 3) After the Formula's settings are deleted, the display will automatically return the F## <formula name> menu.

Set Formula Name

F01 PADS
PRODUCT SETTINGS
SET DEFAULT WEIGHT
SET COUNT PUMP
SET END TIME OFFSET
EDIT NAME
CLEAR FORMULA



NAME F01
▲
PADS
▼
OK EXIT

Clear Formula Settings

F01 PADS
PRODUCT SETTINGS
SET DEFAULT WEIGHT
SET COUNT PUMP
SET END TIME OFFSET
EDIT NAME
CLEAR FORMULA



CLEAR F01
WARNING! FORMULA
WILL BE CLEARED TO
FACTORY DEFAULT!
OK EXIT

11.00 data transfer & units of measure

The easy way to program a Connected Total Eclipse controller is to define the settings and formulas on a computer, using the **Formula Editor** from Hydro Systems, and then transfer the saved Setup File to the controller using a USB drive. (USB drives of 8GB and smaller are recommended.)

The Formula Editor software (and controller language files) can be downloaded from <https://hydrosystemsco.com/downloads/>

When a setup file is saved onto a USB drive, it is easy to transfer the file (in the language used for input) to any Connected Total Eclipse controller, using the controller's **DATA TRANSFER** function.



Remember there are five (5) settings (and the controller menu language, date, and time) that are unique to each controller, **cannot be transferred** via a USB flash drive, and **must be individually set** using each controller's keypad. Those five settings are:

- Installer Password
- Machine Name
- Calibration
- Manager Password
- Company Name

The keypad must also be used to input the Installer Password to access the controller's Installer Menus and the DATA TRANSFER menus.

In these menus, the word **WRITE** means to send data (also called "download") from the controller to the USB flash drive. The word **READ** means to transfer data (also called "upload") from the USB drive to the Controller. These data transfers can take from 2 to 20 seconds or more.



WARNING! All the formulas and settings that are stored in the controller will be erased and overwritten when a setup file is transferred from a USB flash drive to the controller. There is no "undo" function that will restore the overwritten settings and formulas, so be certain before transferring a setup file to the controller.

11.01 Using Formula Editor to Write a New .CTE Setup File

The Hydro Formula Editor Software can be used to write a new setup file for a Legacy Total Eclipse Controller (.SUP file type) or a Connected Total Eclipse controller (.CTE file type). To write a new .CTE file, follow the steps below:

- 1) Install the formula editor software by downloading it from the Hydro Connect website.
- 2) Double-click on the icon to launch the program.
- 3) In the upper left-hand corner, select **File > New Connected TE**
- 4) The screen that opens will display CONNECTED MODE with a blue border as shown below and on the next page.

Take note of the four tabs that make up the setup file and fill in each as appropriate.

(Examples of each page are included for reference on the next page):

- **Setup Summary:** allows for a quick summary/check of all the settings.
- **Control Setup:** allows the user to setup many fundamental controller settings like the Account Name, PI-Selection, Mode of Operation, and Signal Filter Time.
- **Pump Setup:** allows the user to name each Chemical and enter the cost per volume.
- **Formula Setup:** allows the user to name each formula and enter the amounts of each product to be dosed. This is also where the count pump is assigned.

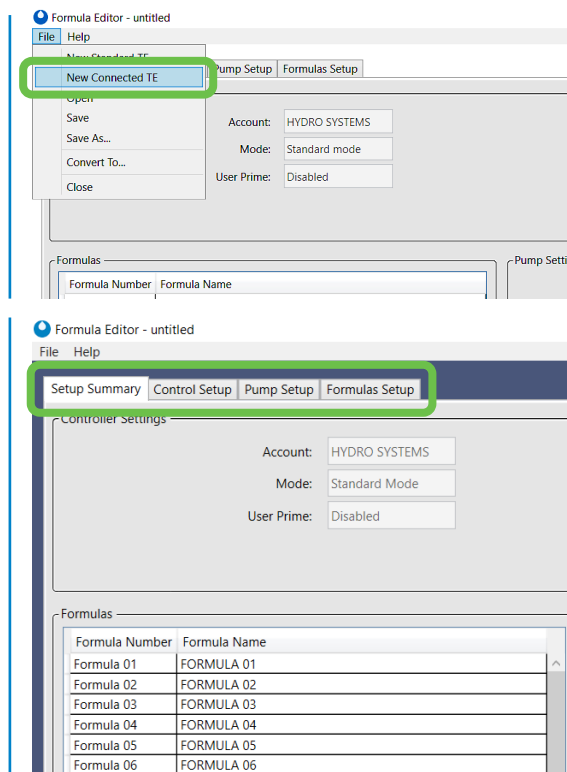

11.00 data transfer & units of measure (continued)

11.01 Using Formula Editor to Write a New .CTE Setup File (continued)

Setup Summary →

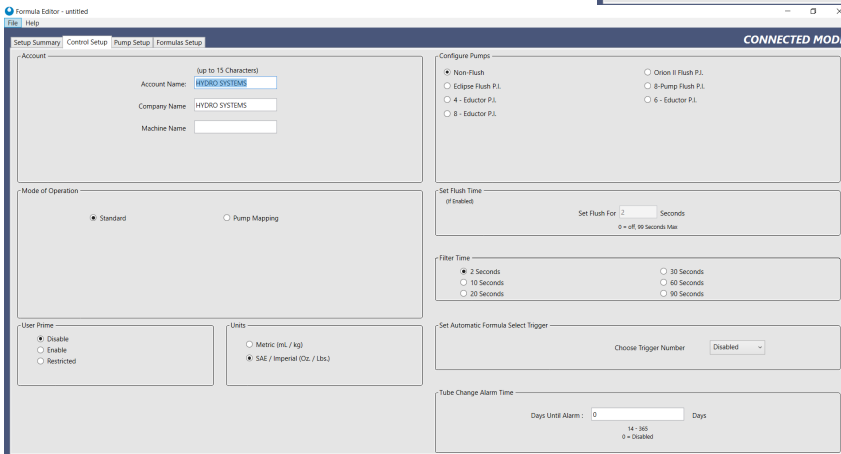
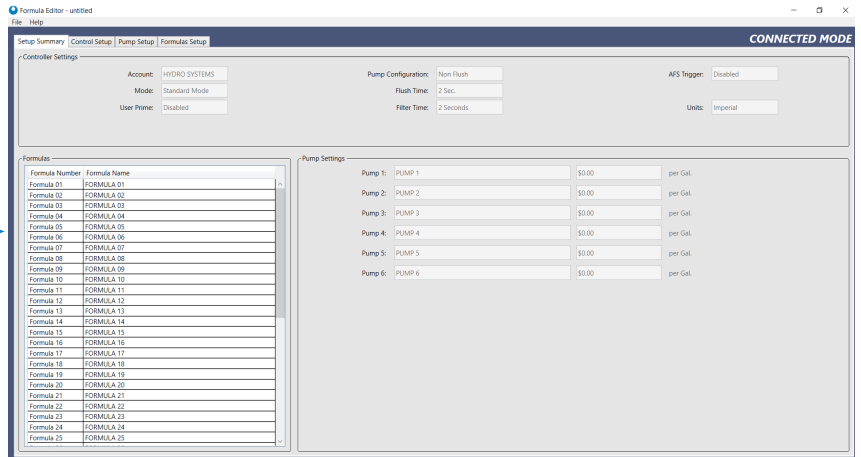

← Control Setup

Pump Setup →

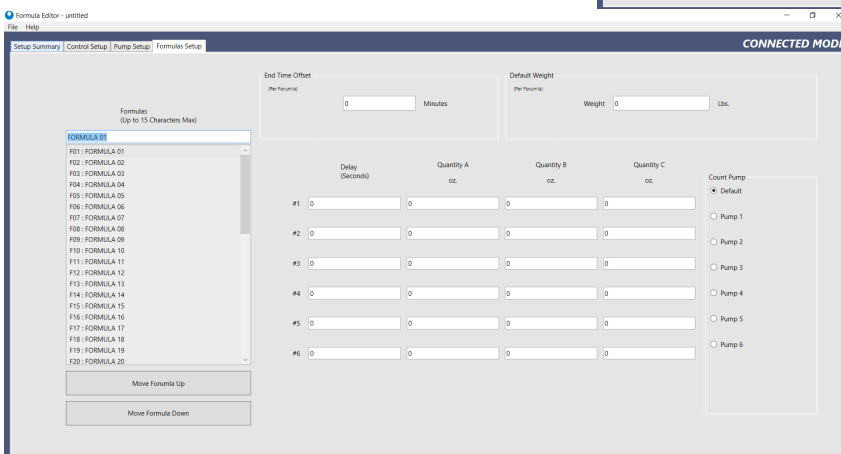
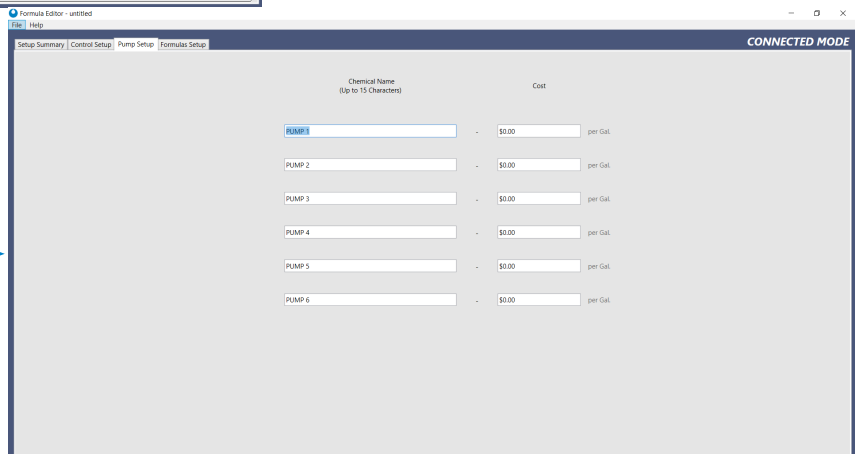

← Formula Setup

11.00 data transfer & units of measure (continued)

11.01 Using Formula Editor to Write a New .CTE Setup File (continued)

When the file is completed, select File > Save As, name the file, and save it to the USB drive so that it is ready to transfer to the Connected TE.

The file extension should be “.CTE”.

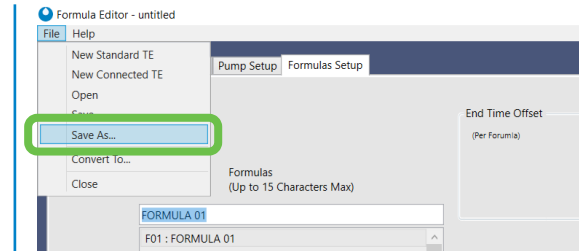

11.02 Converting a .SUP File (Legacy TE) to a .CTE File (Connected TE)

In some instances, it may be useful to convert an existing, legacy Total Eclipse Setup File (.SUP file extension) to a Connected TE Setup File (.CTE file extension). To perform this conversion, follow the steps below:

- 1) Double-click on the icon for the .SUP file to open it in the Formula Editor Software. The screen that opens will display **LEGACY MODE with a gray border**.

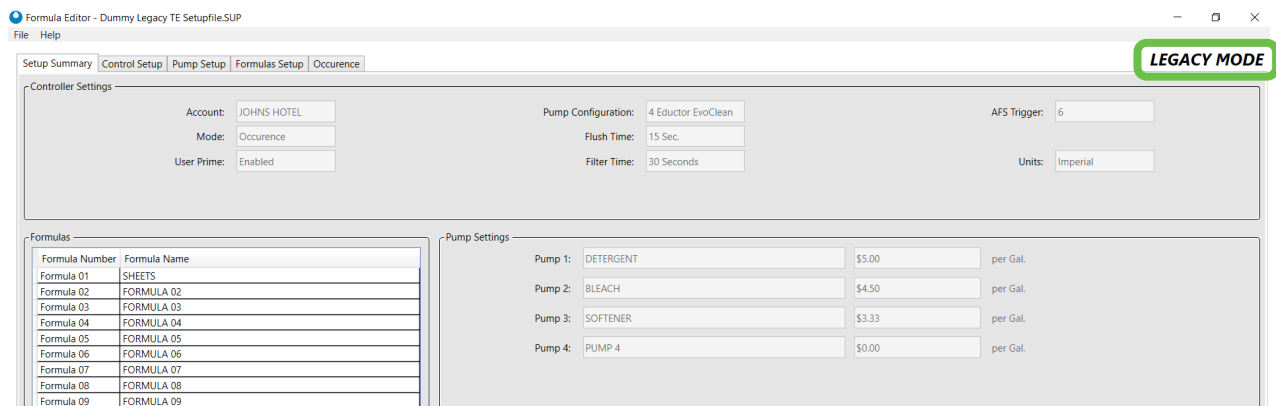

- 2) In the upper left-hand corner, select **File > Convert To...**

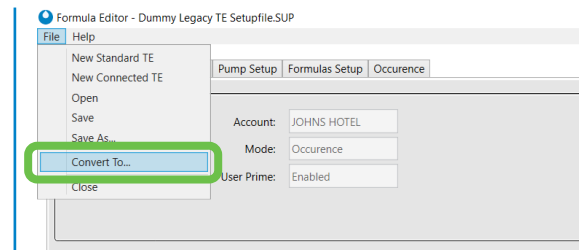

- 3) If you are sure you want to convert the setup file, click **YES** when the message appears as shown to the right. The screen will then change to display in **CONNECTED MODE with a blue border**. Fill out each section of the setup file as noted in Section 11.01.

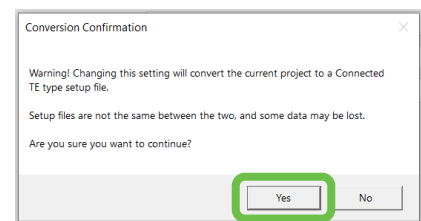

- 4) When the setup file is complete, select **File > Save As**, name the file, and save it to the USB drive so that it is ready to transfer to a Connected TE. The file extension should be “.CTE”.

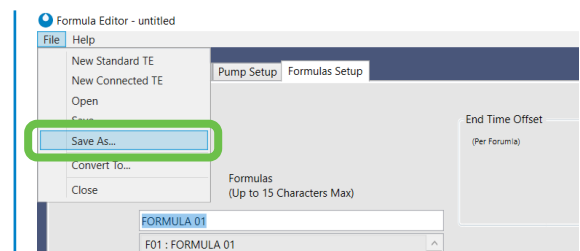

11.00 data transfer & units of measure (continued)

11.03 Read Setup

NOTE! Five settings (plus language, date and time) are NOT INCLUDED in data transfer and are unique to each controller. They are the **Installer Password, Manager Password, Calibration, Machine Name,** and **Company Name.** They must be set individually on each controller. Look for this icon to find the instructions for these settings in this chapter: 

This menu can be used to transfer Setup Files (settings and formulas) from a USB flash drive into a Connected Total Eclipse controller.

If more than six setup files are contained on the USB drive, use the Up / Down Arrow keys to view all the files, on the SETUP FILE selection screen shown to the right.

- 1) At the DATA TRANSFER menu, move the selection box onto the READ SETUP menu item and press the Enter key to launch the SETUP FILE selection screen.
- 2) Use the Up / Down Arrow keys to move the selection box onto the setup file that is to be transferred from the USB drive to the Total Eclipse controller.

(If no setup files displayed, make sure the USB drive is inserted properly. The USB drive must be formatted as "FAT" or "FAT32" and have at least one setup file on it, or the SETUP FILE list will be blank.)
- 3) Press the Enter key to start the setup file transfer. A warning will be displayed that the data transfer will overwrite and erase all existing settings and formulas on the controller (except for the settings described in the note above). Press Enter again to continue, or press Exit to cancel the transfer and return to the DATA TRANSFER menu.

11.04 Write Setup

NOTE! Five settings (plus language, date and time) are NOT INCLUDED in data transfers as they are unique to each controller. They are the **Installer Password, Manager Password, Calibration, Machine Name,** and **Company Name.** They must be set individually on each controller. Look for this icon to find the instructions for these settings: 

Additionally, it is important to verify the PI selection is correct, when transferring a setup file. A warning will appear if a setup file with an Educator PI selected is read into a controller set to a peristaltic PI

The converse of Read Setup, the Write Setup function allows the settings and formulas (that make up a setup file) to be transferred from a Connected Total Eclipse controller to a USB drive.

- 1) At the DATA TRANSFER menu, move the selection box onto the WRITE SETUP menu item and press the Enter key to launch the NAME SETUP input screen.
- 2) Use the Up / Down Arrow keys to edit the character indicated by the digit selection cursor, and use the Left / Right Arrow keys to move the digit selection cursor. Setup file names can be up to 15 characters long.
- 3) Once the setup file name has been input, press the Enter key to start the transfer of the setup file from the controller to the USB drive.

If a setup file with the same name is already on the USB drive, a warning appears. You can overwrite the existing file by pressing the Enter key, or press the Exit key to cancel and input a different name.

(An error message "UNABLE TO OPEN FILE" may appear if the USB drive is full, or if the USB drive is not formatted as "FAT" or "FAT32".)

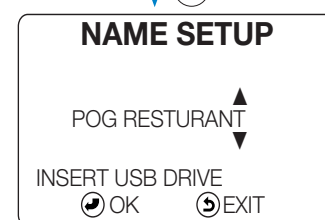
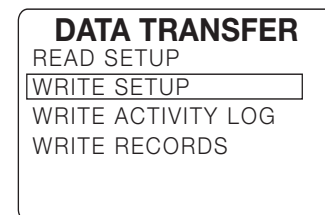
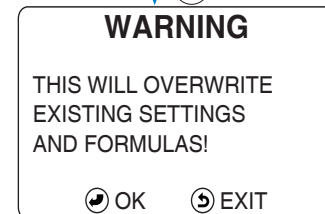
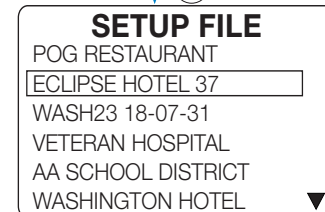
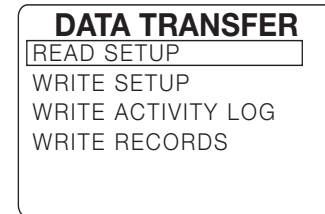

If a file with the same name is on USB drive.

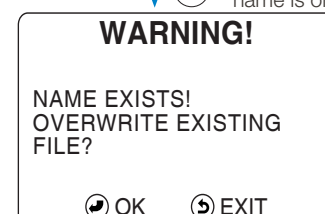

11.00 data transfer & units of measure (continued)

11.05 Write Activity Log

The Activity Log is a detailed diagnostic report used for troubleshooting.

The Activity Log gives added details about a particular wash cycle and/or wash operation. The log contains details about the last 40-50 wash cycles (depending upon the complexity of the cycles), with time-stamped activity of trigger signals, product dispense signals and the flush signal.

No date range can be selected for this report. All activity is printed, from the oldest to the most recent. If the Activity Log buffer is filled, the most recent activity overwrites the oldest activity.

NOTE! The Activity Log can be erased from the controller using the Clear Data Log menu described on page 34.

- 1) At the DATA TRANSFER menu, move the selection box onto the WRITE ACTIVITY LOG menu item and press the Enter key.
- 2) Use the Up / Down Arrow keys to edit the character indicated by the digit selection cursor, and use the Left / Right Arrow keys to move the digit selection cursor. Activity Log names can have up to 15 characters.
- 3) Once the Activity Log name has been input, press the Enter key to start the transfer of the report from the controller to the USB drive.

If an Activity Log with the same name is already on the USB drive, a warning appears. You can overwrite the existing file by pressing the Enter key, or press the Exit key to cancel and input a different name.

(An error message "UNABLE TO OPEN FILE" may appear if the USB drive is full, or if the USB drive is not formatted as "FAT" or "FAT32".)

DATA TRANSFER
READ SETUP
WRITE SETUP
WRITE ACTIVITY LOG
WRITE RECORDS

NAME ACTIVITY LOG
ACTIVITY LOG
INSERT USB DRIVE
OK EXIT

WARNING!
NAME EXISTS!
OVERWRITE EXISTING
FILE?
OK EXIT

If a file with the same name is on USB drive.

11.06 Write Records

All dosing records from the Connected Total Eclipse Controller can be written to the USB drive and then manually uploaded into Hydro Connect to produce professional charts or reports on alarms, productivity (loads and weight), chemical usage, and chemical cost.

Hydro Connect reporting is described in more detail in section 14.00 on page 53.

NOTE! The Records can be erased from the controller using the Clear Data Log menu described on page 34.

- 1) At the DATA TRANSFER menu, move the selection box onto the WRITE RECORDS menu item and press the Enter key to launch the NAME RECORDS input screen.
- 2) Use the Up / Down Arrow keys to edit the character indicated by the digit selection cursor and use the Left / Right Arrow keys to move the digit selection cursor. Report names can have up to 15 characters.
- 3) Once the Report name has been input, press the Enter key to start the transfer of the report from the controller to the USB drive.

If a Records Report with the same name is already on the USB drive, a warning appears. You can overwrite the existing file by pressing the Enter key; or press the Exit key to cancel and input a different name.

(An error message "UNABLE TO OPEN FILE" may appear if the USB drive is full, or if the USB drive is not formatted as "FAT" or "FAT32".)

DATA TRANSFER
READ SETUP
WRITE SETUP
WRITE ACTIVITY LOG
WRITE RECORDS

NAME RECORDS
ECLIPSE HOTEL 37
INSERT USB DRIVE
OK EXIT

WARNING!
NAME EXISTS!
OVERWRITE EXISTING
FILE?
OK EXIT

If a file with the same name is on USB drive.

11.00 data transfer & units of measure (continued)

11.07 Set Units of Measure

When the units of measure are changed, existing volumes and weights, such as doses in a Formula, are properly converted to the new system.

Product cost-per-volume is reset to zero however, and must be re-input. See section 8.08 “Enter Product Costs (Optional)” on page 32.

- 1) At the INSTALLER MENU, move the selection box onto the SET UNITS OF MEASURE menu item and press the Enter key to launch the UNITS-MEASURE selection screen.
- 2) Use the Up / Down Arrow keys to move the selection box onto the desired units, and press the Enter key to make the selection.

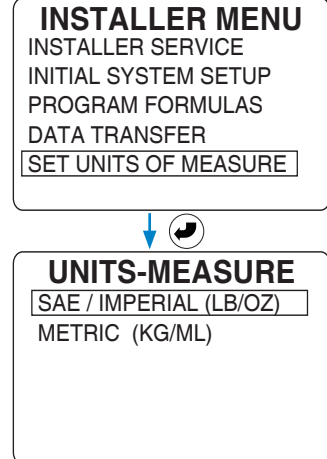

Section 12.00 “Formula Worksheet” starts on the next page.

12.00 formula worksheet

Reproduce this sheet, document your formulas, and keep on file as a backup and as a guide for future installations.

Product #	Product Name	Formula 1				Formula 2				Formula 3				Formula 4			
		A	B	C	Delay	A	B	C	Delay	A	B	C	Delay	A	B	C	Delay
1																	
2																	
3																	
4																	
5																	
6																	
7																	
8																	

Product #	Product Name	Formula 5				Formula 6				Formula 7				Formula 8			
		A	B	C	Delay	A	B	C	Delay	A	B	C	Delay	A	B	C	Delay
1																	
2																	
3																	
4																	
5																	
6																	
7																	
8																	

Product #	Product Name	Formula 9				Formula 10				Formula 11				Formula 12			
		A	B	C	Delay	A	B	C	Delay	A	B	C	Delay	A	B	C	Delay
1																	
2																	
3																	
4																	
5																	
6																	
7																	
8																	

Product #	Product Name	Formula 13				Formula 14				Formula 15				Formula 16			
		A	B	C	Delay	A	B	C	Delay	A	B	C	Delay	A	B	C	Delay
1																	
2																	
3																	
4																	
5																	
6																	
7																	
8																	

13.00 transfer setup file (to USB flash drive)

13.01 Transferring a Formula Editor Setup File

The easy way to program a Connected Total Eclipse controller is to define the settings and formulas on the computer, using the Formula Editor from Hydro Systems, and then transfer the saved Setup File to the controller using a USB drive.

The Formula Editor software (and controller language files) can be downloaded from www.hydrosystemsco.com.

When a setup file is saved onto a 8 GB or smaller USB drive, it is easy to transfer the file (in the language used for input) to any Total Eclipse controller, using the controller's DATA TRANSFER function.

Remember there are five (5) settings (and the controller menu language, date, and time) that are unique to each controller, cannot be transferred via a USB flash drive, and must be individually set using each controller's keypad. Those five settings are: **Installer Password**, **Manager Password**, **Machine Name**, **Company Name**, and **Calibration**. The keypad must also be used to input the Installer Password to access the controller's Installer Menus and the DATA TRANSFER menus.



WARNING! All the formulas and settings that are stored in the controller will be erased and overwritten when a setup file is transferred from a USB flash drive to the controller. There is no "undo" function that will restore the overwritten settings and formulas, so be certain before transferring a setup file to the controller.

13.02 Access to Data Transfer Menu

To do the data transfer of the setup file to the controller, access to the DATA TRANSFER menu within the INSTALLER MENU is required, and the Installer Password.

- 1) Press the Enter key on an idle controller to display the MAIN MENU, then use the Up / Down Arrow keys to move the selection box onto the INSTALLER MENU item.
- 2) Press the Enter key to launch the Installer Password input screen. The factory default installer password is 01234. It is highly recommended that the password be changed from the default to prevent unauthorized access to the installer functions!!
- 3) On the INSTL PASSWORD input screen use the Up / Down Arrow keys to change the number indicated by the digit selection cursor, and use the Left / Right Arrow keys to move the digit selection cursor. Installer passwords are numbers only and five digits in length. Once the proper password has been input, press the Enter key to launch the Installer Menus.
- 4) In the Installer Menu move the selection box onto the DATA TRANSFER menu item and press the Enter key to launch the Data Transfer menus. See "Data Transfer & Units of Measure" on page 45 for more details.

Access to the Data Transfer Menu

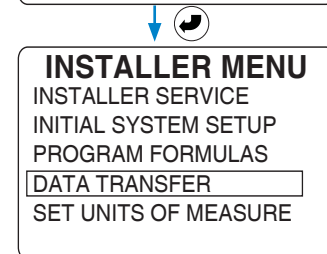
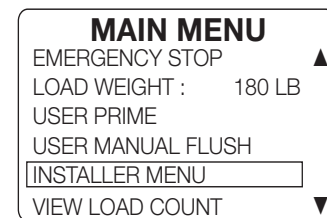

13.03 Additional Data Transfer Information

It is possible to transfer setup files between Connected Total Eclipse controllers or create and save controller usage reports (in HTML format) from a controller to a computer via a USB flash drive. (See "Data Transfer & Units of Measure" on page 45 for more details.)

Language Files:

- Two types of language files can be downloaded from Hydro Systems' website. A Formula Editor language file changes only the menu screens in Formula Editor software (file extension **.properties**). These language files should be downloaded to the computer on which the Formula Editor is used and placed in the Program Files \ Hydro Controls \ Formula Editor \ Languages folder. Start the Formula Editor and click Tools / Customize / Languages to select the new language.
- To change the Connected Total Eclipse controller's menu language, you must download a controller language file (file extension **.LNG**) to a USB flash drive. Power off the TOTAL ECLIPSE controller, connect the USB flash drive, and restore power to the controller. Select the new language when the LANGUAGE menu appears.

14.00 reporting through Hydro Connect

The data generated by the Connected Total Eclipse Controller can be transmitted to Hydro Connect in one of two ways:

- 1) By manually uploading it using the WRITE RECORDS functionality to the USB drive (no gateway required).
- 2) By automatically streaming it to Hydro Connect through a cellular gateway.

Below is a description of how to access Hydro Connect and each report that is provided for a Connected Total Eclipse installation.

14.01 Logging in to Hydro Connect

To access your dispenser via Hydro Connect, you must be set up as a user within your company hierarchy.

If you are not yet set up, you may:

- Contact your Company Admin who manages all the Hydro Connect users
- Contact Hydro via 800-543-7184 or contact-hydro@hydrosystemsco.com
- Fill out and submit a new user request form

Once your user profile is set up in Hydro Connect (by either a Hydro or Company Admin) you will be sent an email with your “username” and a temporary password.

Now you must log in to Hydro Connect using that username and temporary password, where you will be prompted to reset the temporary password with a personal password. At that point, you may navigate to any of the Sites to which you have been given Company access.

Log in at Hydro Connect:

Navigate to the Hydro Connect web page at www.hydroconnect.com. At the Home page, enter your username (usually your first initial and last name, with no spaces) and click the field or press Return to move to the password entry. Enter your personal password and click the “Sign in” button.

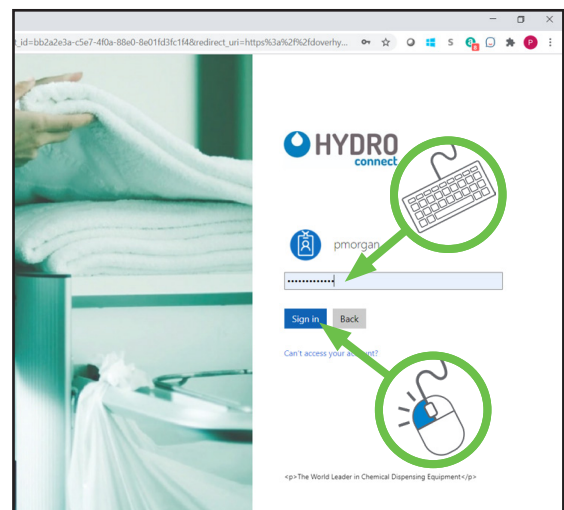
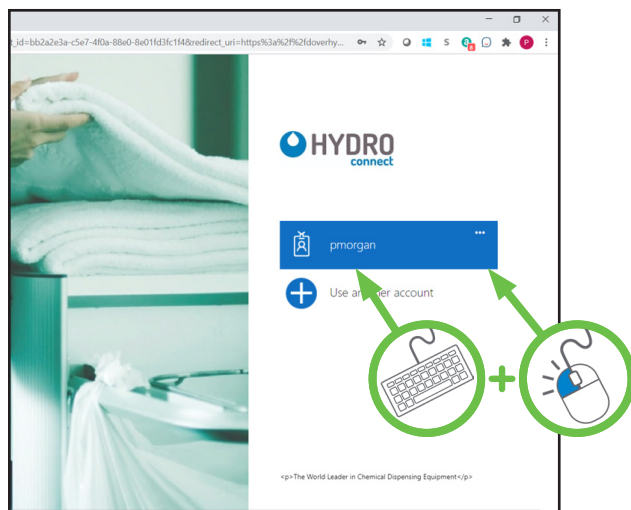

14.02 Basic Navigation

Options on the Reports Landing Page:

After logging in, by default you will land in the **Reports** section since this is the section of Hydro Connect that most users will use to access device data.

For the sites and dispensers you are responsible for, this section allows a user to access either the **Real-time Dashboard** or **Historical Reporting**, by clicking the corresponding item in the left side list.

Additionally, on the left side list there is an **Admin** access that allows certain users to create and edit company, account, site, user, and device settings. (See the images on the following page.)

14.00 reporting through Hydro Connect (continued)

14.02 Basic Navigation (continued)

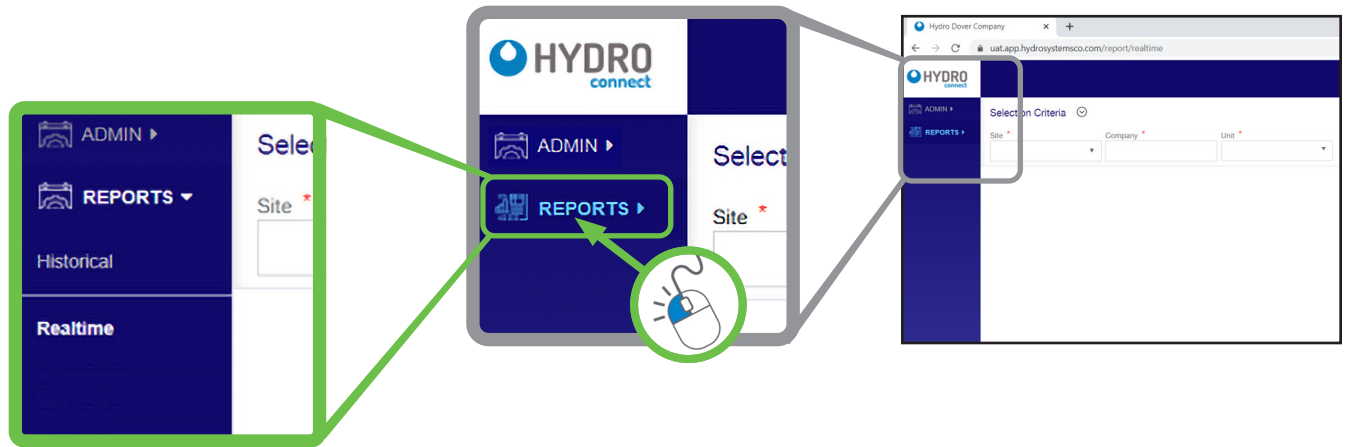

14.03 Real-time Dashboard for Washer Extractors

Systems that are equipped with the enabling hardware (e.g. cellular gateway) and service will have access to the real-time dashboard.

This allows users to see a live display of the laundry (or other operating environment), the status of the washers, alarm conditions, and operational metrics like turn times and efficiency.

To access the real-time dashboard, select the **Site Name** from the drop-down menu. (You may enter part of the Site Name to limit the entries in the drop-down menu.) The **Company** field will self-populate once the site is selected. Pick the **Dositec Unit** at that site, whose status you wish to see, and then click **View**.

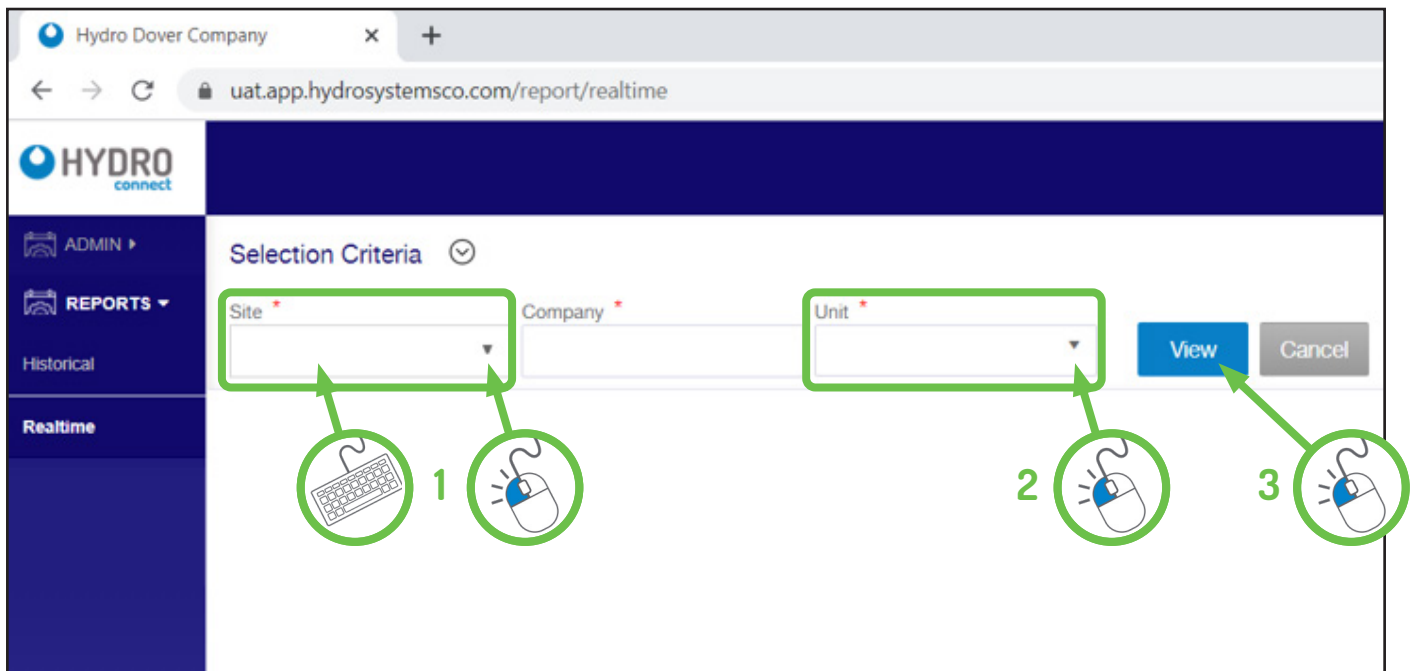

Note: Each user will only see those sites that they have responsibility for. If you do not see a site that you are responsible for listed, contact your Company Admin.

14.00 reporting through Hydro Connect (continued)

14.03 Real-time Dashboard for Washer Extractors (continued)

Once you have selected a site location and a unit at that site; when you click View, the Real-time Dashboard for that unit will be displayed. See the examples shown below.

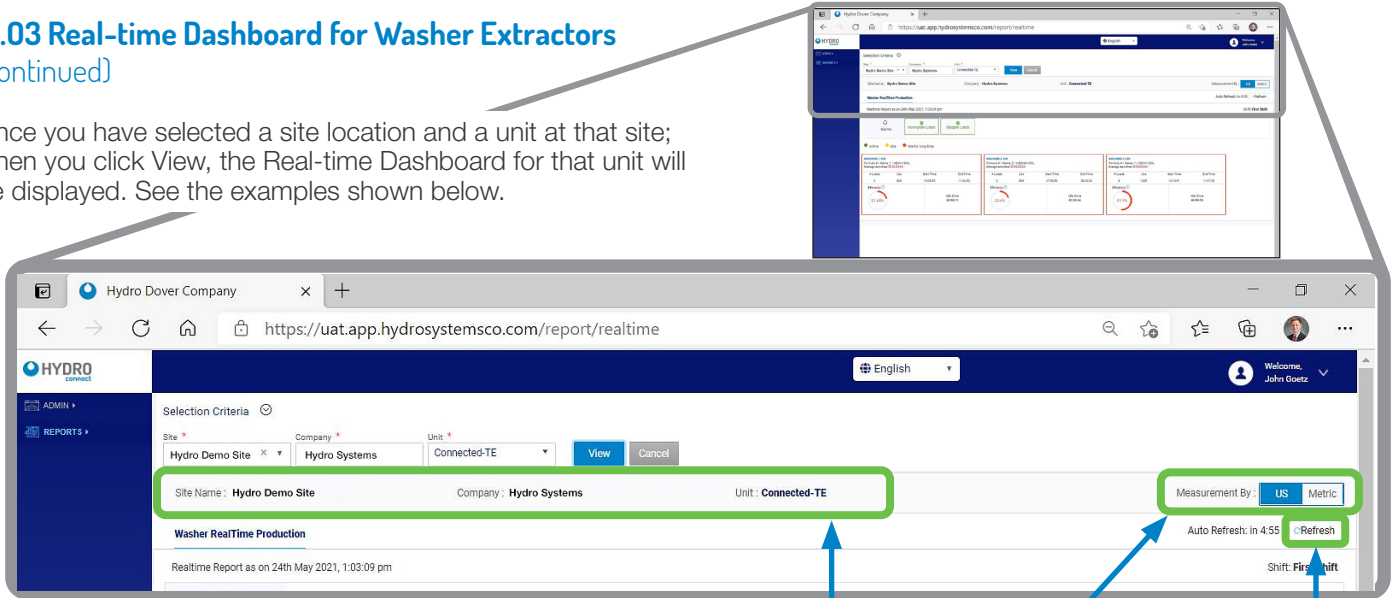

At the top of the screen, the name of the site, company, and unit will be summarized. Additionally, on the upper right-hand side of the screen there is a toggle to change the units of measure from US to Metric depending on the user's preference and a refresh button that will update the display with the latest information. If the refresh button is not pressed, the system will automatically countdown and refresh on a 5-minute interval.

Site Summary

Units of Measure Selector

Refresh

In the middle of the screen is the Washer Real-Time Production display of the current date and time, shift and alarm status.

Washer Real-Time Production

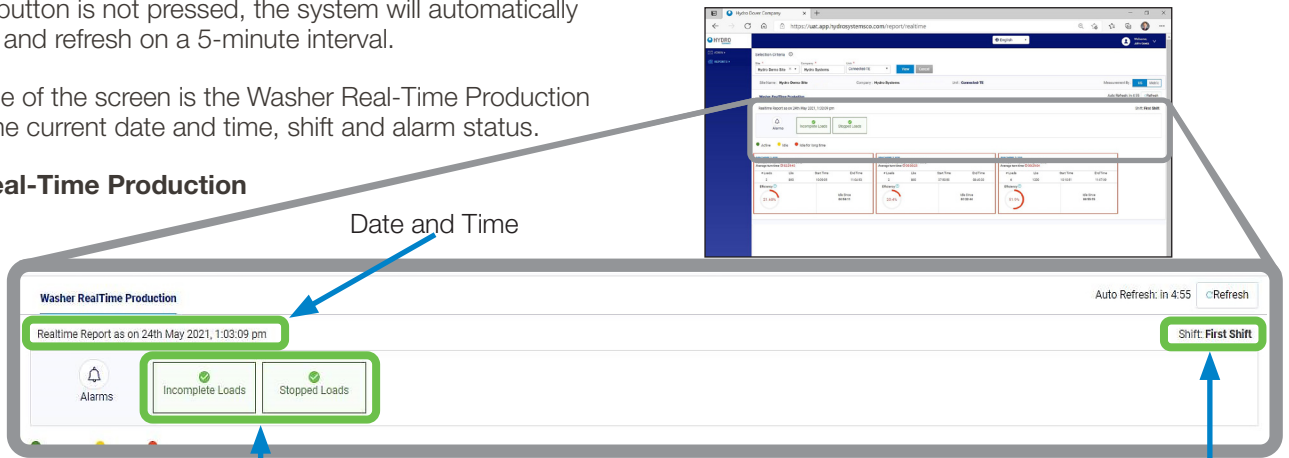

Washer Displays

Alarms Status Bar

Shift Display

Toward the bottom of the screen you will see the washer displays, each with real-time status information for that particular washer.

Washer Box Color Indicates Status

Green = Running
Yellow = Idle
Red = Idle "Too Long"

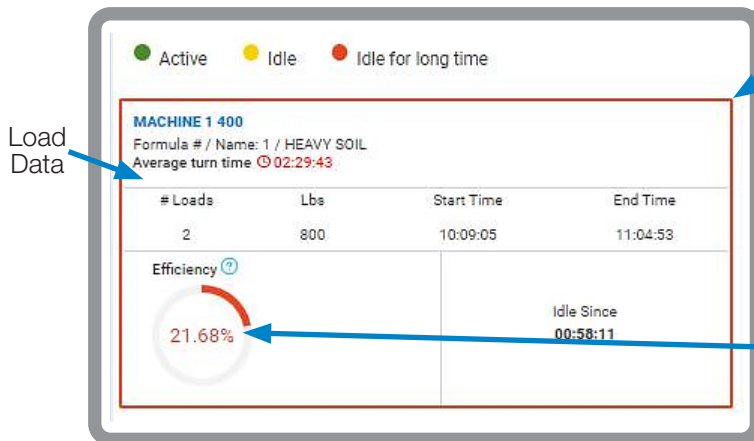

Load Data

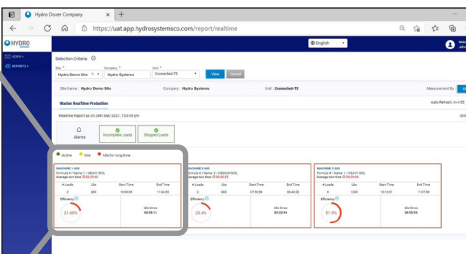

Efficiency = Total Active Time divided by Total Elapsed Shift Time

Circle is Blue = Above User Percentage Setting
Circle is Red = Below User Percentage Setting

14.00 reporting through Hydro Connect (continued)

14.03 Real-time Dashboard for Washer Extractors (continued)

Washer Displays (continued)

As illustrated on the previous page; at the bottom of the Washer Displays section are boxes that show all the critical data for each washer, including:

- **Washer status:** denoted by the box color, with green = washer is active, yellow = idle (not running a cycle), or red = idle for “too long” (beyond a user defined threshold in the Site Setup screen in the Admin menu).
- **Current Formula Name:** displays the current active formula or if idle/idle long, the last formula to complete.
- **Average turn time:** For all completed loads in the shift, this will show the average amount of time to turn the washer from the end of a cycle to the beginning of the next cycle.
- **# of Loads** run in the current shift.
- **Weight (Lbs or Kg)** is the weight of the current load or cycle.
- The **Start Time** of the current active load or last completed load (if idle).
- The **End Time** of the last completed load (if idle).
- **Washer efficiency:** This is calculated by taking the Active time in the shift divided by the total elapsed time in the shift. The color of the efficiency is blue if it is above a user defined threshold and red if it is below. Thresholds are defined in the Site Setup screen in the Admin menu.
- **Idle time:** a counter that displays the current idle time since the last load completed.

14.04 Historical Reports for Washer Extractors

In addition to the real-time information, historical reports on alarms, production (number of loads and weight), chemical usage, and costs are also available through Hydro Connect.

Simply click the **Historical** menu item in the left-side list to display the Selection Criteria, as shown below. Start by selecting the **Site Name** from the drop-down menu. (You may enter part of the Site Name to limit the entries in the drop-down menu.) The **Company** field will self-populate once the site is selected. Pick the **Unit** at that site, whose data you wish to see and then select the **View By** option. There are three “View By” options: Monthly, Date and Date Range. Each option has different criteria for the “time” range of the data retrieval. When you have set the View By criteria, click **View** to see the report.

The screenshot shows the 'Selection Criteria' form in the Hydro Connect interface. The form includes a left sidebar with 'ADMIN', 'REPORTS', 'Historical', and 'Realtime' options. The main form has fields for 'Site', 'Company', 'Unit', 'View By' (set to 'Monthly'), 'Month', and 'Year'. A green box highlights the 'Site', 'Company', 'Unit', and 'View By' fields. Four numbered callouts (1-4) with mouse icons point to the Site, Company, View By, and View buttons respectively.

View By Criteria:

- **Monthly:**
You select the Month and Year.
- **Date:**
You select the Calendar Date and the Shift on that date.
- **Date Range:**
You select a Start Date and End Date.

The screenshot shows the 'Monthly' View By criteria form. It includes a 'View By' dropdown set to 'Monthly', 'Month' and 'Year' dropdown menus, and 'View' and 'Cancel' buttons.

The screenshot shows the 'Date' View By criteria form. It includes a 'View By' dropdown set to 'Date', a 'Date' field with a calendar icon, a 'Shift' dropdown, and 'View' and 'Cancel' buttons.

The screenshot shows the 'Date Range' View By criteria form. It includes a 'View By' dropdown set to 'Date rang', 'From' and 'To' fields with calendar icons, and 'View' and 'Cancel' buttons.

14.00 reporting through Hydro Connect (continued)

14.05 Historical Reports - Monthly & Date Range

Each of the View By criteria will produce slightly different Historical Reports. The Monthly and Date Range choices produce similar reports with the most options, so those two report formats will be discussed first.

Historical Reports - Monthly and Date Range:

When either Monthly or Date Range is selected in the View By drop-down menu, multiple tabs of reports will be displayed, starting with the Alarm Summary. Users can quickly cycle between the tabs to locate the specific information desired.

The screenshot shows the 'Selection Criteria' section with the following values: Site: PSG CINCY DEMO L...X, Company: Test Company, Unit: MULTI WASHER 1, View By: Monthly, Month: October, Year: 2020. The 'Alarm Summary' tab is selected, displaying a table of alarm types and their occurrences across three washers. A callout box highlights that clicking a number in the center section provides deeper details.

Alarm Type	Warnings	Machines	1.Washer 1	...	2.Washer 2	...	3.Washer 3	...
Air Pressure Failure								
Cycles With Missed Phases	81	3	37		11		33	
Flow Meter Error For Product Dosage	31	3	7		16		8	
Flow Meter Error For Water Flush								
Leak Test Failure								
Minimum Levels Of Product								
Unfinished Cycle	57	3	20		7		30	
Unit Locked								

Alarm Summary:

The Alarm Summary lists the total number of warnings, the types and occurrences of each of the **nine** alarm types for each washer during the designated reporting period (not all shown above). Below is a description of each alarm type for reference:

- 1) Tube Change Alarm:** Occurs when the current date exceeds the last squeeze TUBE CHANGE DATE entered on the controller, plus the TUBE ALARM days entered on the controller.

For example, if the tube was changed on March 1, 2021 and the TUBE ALARM days is set to 30, the alarm will register on all loads after March 31, 2021 if the tube has not been serviced and the TUBE CHANGE DATE updated.
- 2) Memory Overflow:** Occurs when the records on the Connected Total Eclipse Controller are not streamed to Hydro Connect and local memory is full.
- 3) Stopped Cycle:** Occurs when a load is stopped without the Count Pump dispensing it's last programed amount.
- 4) Incomplete Cycle:** Occurs when the count pump runs before one or more products programmed in the formula did not get dispensed.

14.00 reporting through Hydro Connect (continued)

14.05 Historical Reports - Monthly & Date Range (continued)

Washer Production:

The Washer Production report provides a summary of the total weight and number of loads produced by the laundry during the reporting period.

This total is further broken down by washer and by formula to give a full picture of the site's absolute and percentage totals.

The default view for this report is a table, shown below, but by clicking the **View By** selector at the upper right, the user can toggle to a bar-chart view by weight or by loads as well.

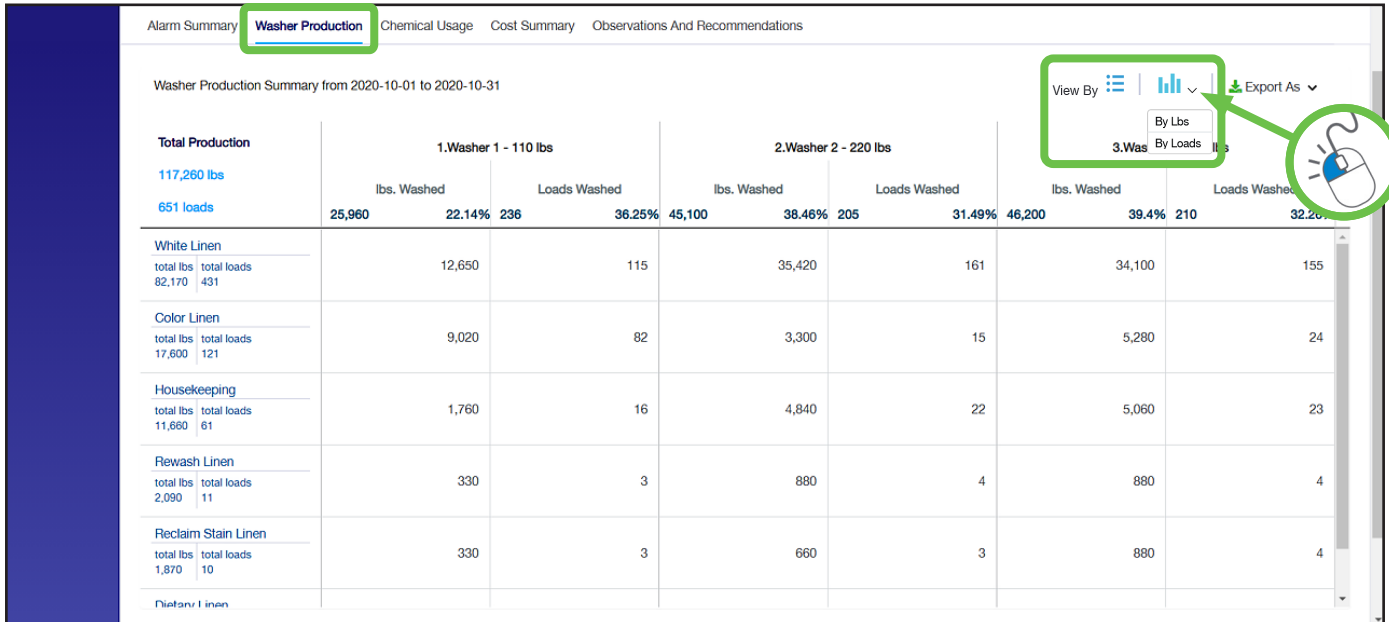

Total Production	1.Washer 1 - 110 lbs		2.Washer 2 - 220 lbs		3.Washer 3 - 220 lbs								
	lbs. Washed	Loads Washed	lbs. Washed	Loads Washed	lbs. Washed	Loads Washed							
117,260 lbs 651 loads	25,960	22.14%	236	36.25%	45,100	38.46%	205	31.49%	46,200	39.4%	210	32.20%	
White Linen total lbs total loads 82,170 431	12,650		115		35,420		161		34,100		155		
Color Linen total lbs total loads 17,600 121	9,020		82		3,300		15		5,280		24		
Housekeeping total lbs total loads 11,660 61	1,760		16		4,840		22		5,060		23		
Rewash Linen total lbs total loads 2,090 11	330		3		880		4		880		4		
Reclaim Stain Linen total lbs total loads 1,870 10	330		3		660		3		880		4		
Dietary Linen													

In the bar chart views, there is a control at the top-left side of the chart that allows the user to view either a total for the whole system or view one bar per washer.

The red lines on these charts indicate the 3-month average production level as a method for gauging whether the current period is above or below normal.

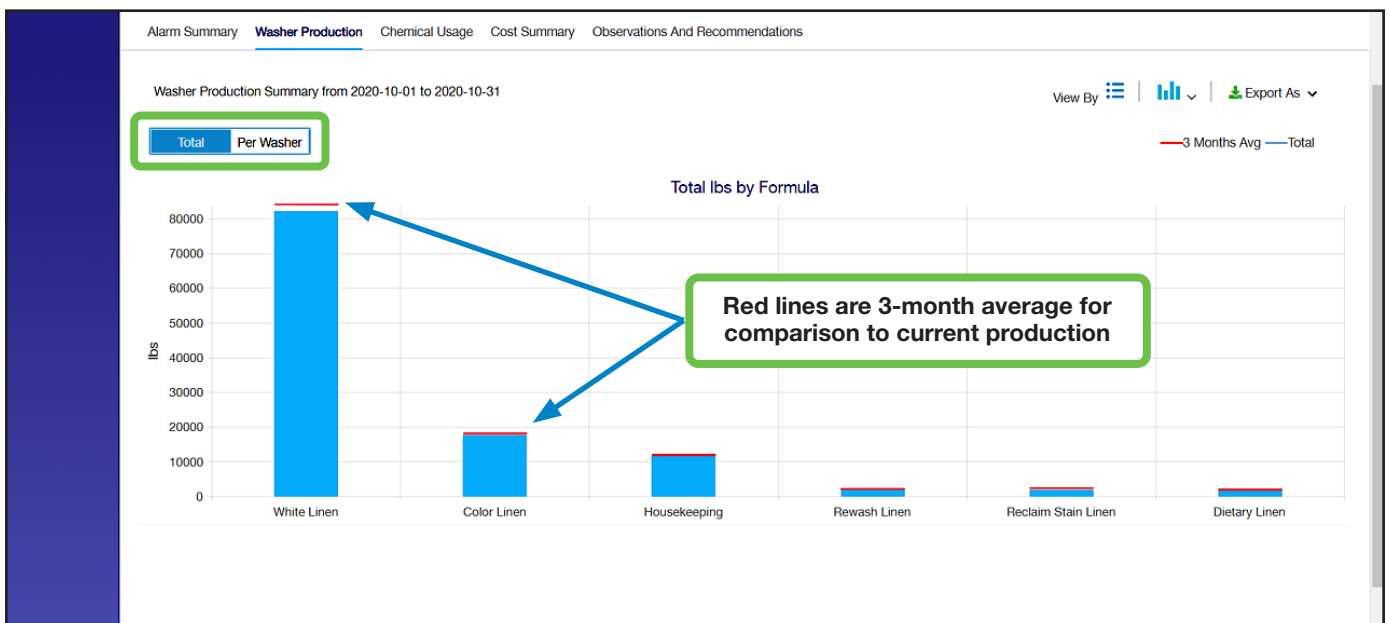

14.00 reporting through Hydro Connect (continued)

14.05 Historical Reports - Monthly & Date Range (continued)

Washer Production: (continued)

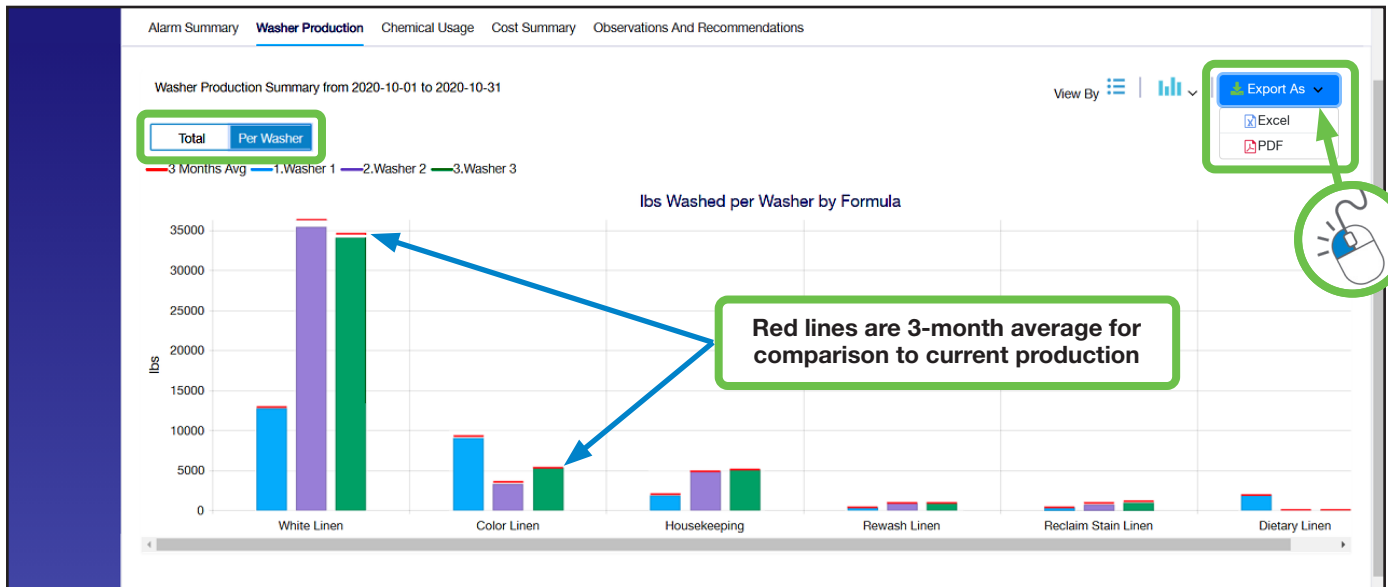

Note: There is a report export option at the upper right of the chart, as on all the Hydro Connect reports. Click **Export As** to download a digital copy of a report, in either Excel or PDF format.

Chemical Usage:

The Chemical Usage report provides a summary of the total volume of each chemical used with a breakdown by formula.

The default view for this report is a table, shown below, but by clicking the **View By** selector at the upper right, the user can toggle to a bar-chart view.

Realtime

Site Name : PSG CINCY DEMO LDY Company : Test Company Unit : MULTI WASHER 1 Measurement By : US Metrics Export All

Alarm Summary Washer Production **Chemical Usage** Cost Summary Observations And Recommendations

Chemical Usage Summary from 2020-10-01 to 2020-10-31

View By: [List Icon] [Bar Chart Icon] Export As: [Excel Icon] [PDF Icon]

	Softener		Builder		Chlorine		Detergent		Sour	
	Actual Usage (gal)	Error (%)	Actual Usage (gal)	Error (%)	Actual Usage (gal)	Error (%)	Actual Usage (gal)	Error (%)	Actual Usage (gal)	Error (%)
	36.317		229.634	-2.335	147.701	-2.849	79.527		16.699	
Color Linen	3.781		30.905	-2.698			17.652		1.942	
Reclaim Stain Linen	0.473						0.98		0.095	
Rewash Linen	0.825		4.091		2.542	-7.564	1.633		0.413	
White Linen	31.238		170.726	-2.405	133.47	-2.894	50.806		12.461	
Dietary Linen			4.125				1.65			
Housekeeping			19.787	-2.103	11.689	-1.225	6.806		1.788	

(The bar chart Chemical Usage Report is shown on the next page.)

14.00 reporting through Hydro Connect (continued)

14.05 Historical Reports - Monthly & Date Range (continued)

Chemical Usage: (continued)

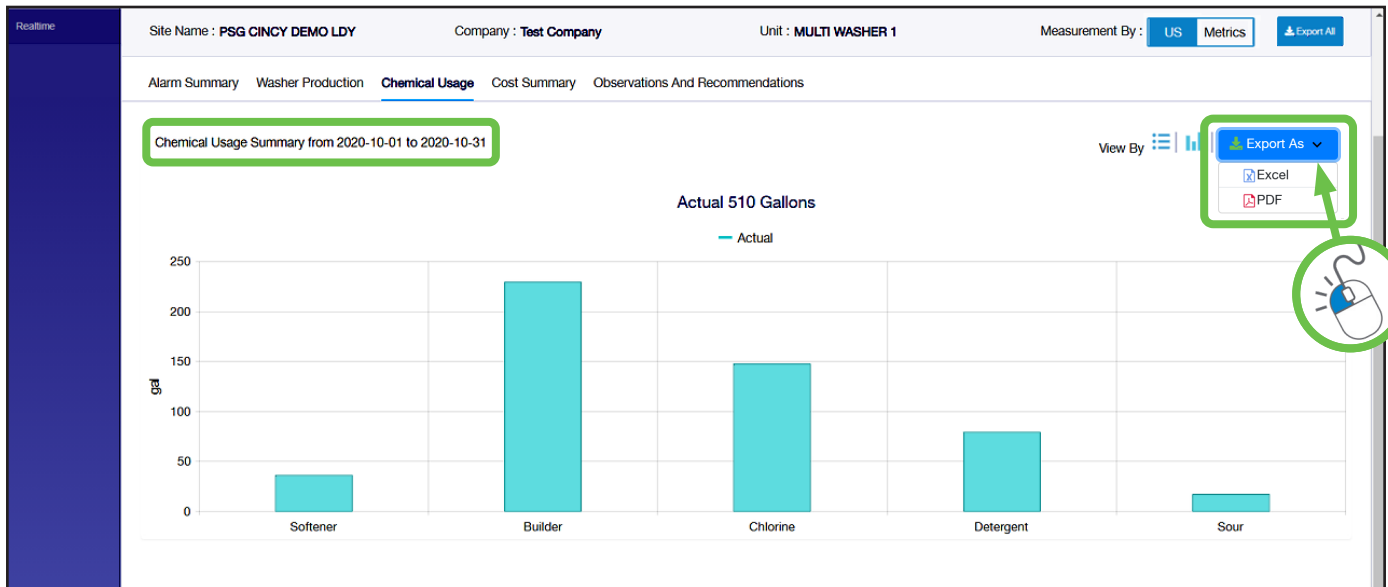

Note: There is a report export option at the upper right of the chart, as on all the Hydro Connect reports. Click **Export As** to download a digital copy of a report, in either Excel or PDF format.

Cost Summary:

The Cost Summary report provides a view of the absolute cost and the cost-per-weight (100 lbs or kg) in total and per formula.

The default view for this report is a table, shown below, but by clicking the **View By** selector at the upper right, the user can change to a bar-chart view for the absolute cost or cost-per-weight by formula.

	Washed lbs	Real Cost		Error (%)
		(Absolute)	(Per CWT)	
	117,260	3,045.03 difference 23.126	2.597 difference 0.02	
White Linen	82,170	2,271.925	2.765	-0.861
Color Linen	17,600	422.066	2.398	-0.374
Housekeeping	11,660	235.086	2.016	-0.641
Rewash Linen	2,090	58.818	2.814	-0.106
Dietary Linen	1,870	42.075	2.25	
Reclaim Stain Linen	1,870	15.06	0.805	

(A bar-chart style Cost Summary Report is shown on the next page.)

14.00 reporting through Hydro Connect (continued)

14.05 Historical Reports - Monthly & Date Range (continued)

Cost Summary: (continued)

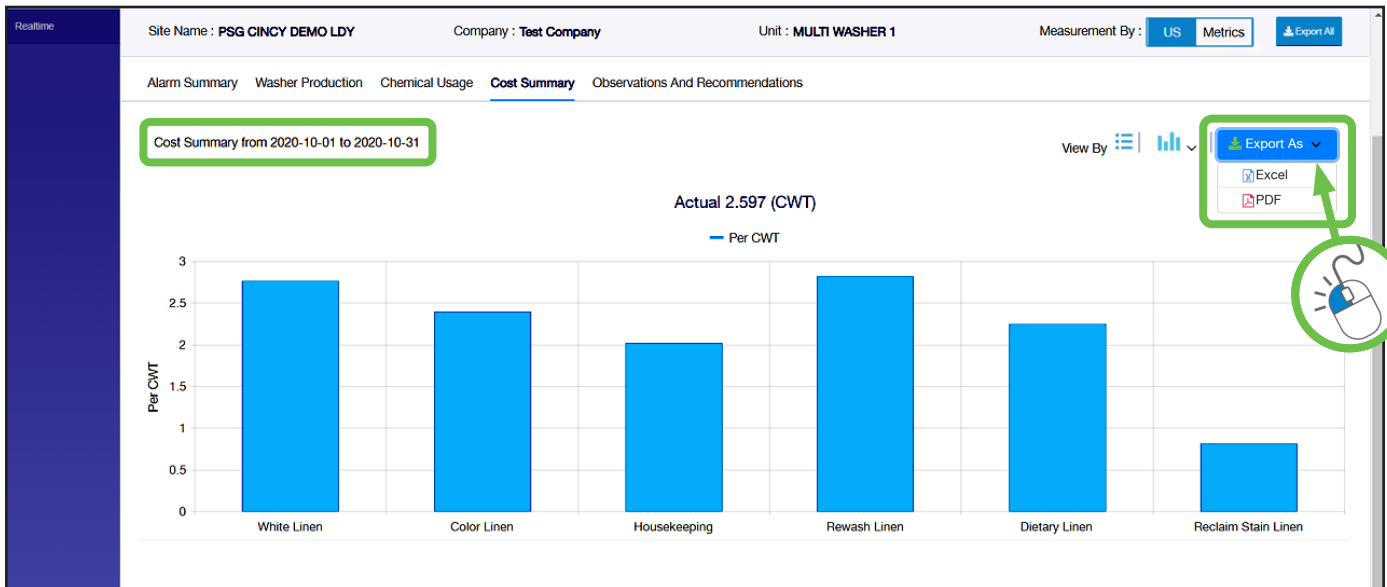

Note: There is a report export option at the upper right of the chart, as on all the Hydro Connect reports. Click **Export As** to download a digital copy of a report, in either Excel or PDF format.

Observations and Recommendations:

The **fifth tab** on the Historical **Monthly** Reports is for the monthly **Observations and Recommendations** Report and therefore is **not** shown on the Historical **Date Range** Reports.

The monthly Observations and Recommendations Report is available on a subscription basis. An experienced Hydro Laundry Specialist will review the Alarm Summary Report and make Observations regarding the various alarms reported along with Recommendations to correct the alarms or help pinpoint the source of the alarms.

Selection Criteria

Site : ABC CENTRAL LAU ... Company : ABC Chemical Company Unit : DOSING UNIT 1 View By : Monthly Month : July Year : 2020 View Cancel

Site Name : ABC CENTRAL LAUNDRY Company : ABC Chemical Co. Unit : DOSING UNIT 1 Measurement By : US Metrics Export All

Alarm Summary Washer Production Chemical Usage Cost Summary **Observations And Recommendations**

Filter by keywords Add New Export As

#	Observations	Recommendations	Last Modified By / Date	Actions
1	There are 303 cycles with missed phases and 258 Unfinished cycles. Generally, this is an indication of programming errors on the dispenser or machine or both. These errors are not common to one or two cycles. Most of the cycles are recording these errors.	Every cycle on the machine should be checked for proper signal programming and insure that these signals match the phases programmed on the dispenser. We can assist in finding the errors if the machine programs are sent to us to compare with the dispenser program. We have access to the dispenser p ...	Bernie Samaniego 2021-01-21 10:16:07	Export All

1 - 1 of 1 items

14.00 reporting through Hydro Connect (continued)

14.06 Historical Reports - Date

If Date is selected in the View By menu, a summary for each washer's production will be displayed for a single day.

Just choose the Date from the calendar and the Shift from the drop-down menu and click View.

Selection Criteria

Site * PSG CINCY DEMO L... Company * Test Company Unit * MULTI WASHER 1 View By * Date Date * 2020-10-15 Shift * Full Day x View Cancel

1 2 3 4

Please fill the selection criteria and click on View button to generate report

Selection Criteria

Site * PSG CINCY DEMO L... Company * Test Company Unit * MULTI WASHER 1 View By * Date Date * 2020-10-15 Shift * Full Day x View Cancel

Site Name : PSG CINCY DEMO LDY Company : Test Company Unit : MULTI WASHER 1

Washer Production Summary on 2020-10-15

Washer 1	Efficiency	Washer 2	Efficiency	Washer 3	Efficiency
Average turn time 00:07:25	27.23%	Average turn time 00:48:34	14.46%	Average turn time 00:29:47	21.08%
# of Loads 6		# of Loads 5		# of Loads 7	
Washed Lbs 660		Washed Lbs 1100		Washed Lbs 1540	

Click any individual washer display to access a detailed, machine-specific production report for this day.

The resulting View By Date report (shown above) allows operators to see a summary of each washer in the facility with a breakdown of loads and weight run along with washer efficiency and average turn time on that date.

To see the details for an individual washer, simply click the washer of interest to display its **Daily Washer Report**. This report will show specific information about the loads and formulas run for that particular washer on that day.

(An example of the individual Daily Washer Report is shown on the following page.)

14.00 reporting through Hydro Connect (continued)

14.06 Historical Reports - Date (continued)

Daily Washer Report:

The default view for the Daily Washer Report is the **FORMULA** view that displays each formula run and the number of occurrences of each formula.

Formula #	Name	# of Occurrences
1	White Linen	4
4	Housekeeping	1

To switch to the MACHINE view, simply click the Machine option, shown above at the left side of the report.

The **MACHINE** view shows each formula run, the start and stop time, total elapsed time, turn time, and whether there were any problems dosing the individual phases. This display can be used by laundry operators each day to check for any dosing issues that require attention. (As always, there is an **Export As** report option at the upper right of the page, to download a digital copy in either Excel or PDF format.)

Cycle Id	Formula	Name	Start Time	Stop Time	Total Elapsed time	Turn Time	Phases
> 2341	4	Housekeeping	Oct 15, 2020 6:24:23 AM	Oct 15, 2020 7:01:35 AM	00:37:12		✓✓✓✓ 4 5 6 7 8
> 2344	1	White Linen	Oct 15, 2020 9:32:07 AM		01:03:17	02:30:32	1 2 3 4 5 6 7 8
> 2345	1	White Linen	Oct 15, 2020 10:35:24 AM	Oct 15, 2020 10:57:13 AM	00:21:49	00:00:00	1 ✓✓✓✓ 4 5 6 7 8
> 2346	1	White Linen	Oct 15, 2020 11:19:47 AM	Oct 15, 2020 12:02:35 PM	00:42:48	00:22:34	✓✓✓✓ 4 5 6 7 8
> 2347	1	White Linen	Oct 15, 2020 12:23:46 PM	Oct 15, 2020 1:06:56 PM	00:43:10	00:21:11	✓✓✓✓ 4 5 6 7 8

An operator can simply **click the down arrow** on the left side of the formula entry (as shown below) to expand the selection to show each individual product dosage; including the product dosed, the actual volume dispensed, and the time to do so.

Cycle Id	Formula	Name	Start Time	Stop Time	Total Elapsed time	Turn Time	Phases																																			
> 2341	4	Housekeeping	Oct 15, 2020 6:24:23 AM	Oct 15, 2020 7:01:35 AM	00:37:12		✓✓✓✓ 4 5 6 7 8																																			
<table border="1"><thead><tr><th>Timestamp</th><th>Phase</th><th>Product #</th><th>Product Name</th><th>Oz</th><th>TimeEstimated</th><th>TimeActual</th></tr></thead><tbody><tr><td>Oct 15, 2020 6:25:29 AM</td><td>1 ✓</td><td>1</td><td>Detergent</td><td>17.6</td><td>13.1</td><td>7.5</td></tr><tr><td>Oct 15, 2020 6:26:08 AM</td><td>1 ✓</td><td>2</td><td>Builder</td><td>52.8</td><td>38.2</td><td>25.8</td></tr><tr><td>Oct 15, 2020 6:40:35 AM</td><td>2 ✓</td><td>3</td><td>Chlorine</td><td>37.4</td><td>25.4</td><td>15.0</td></tr><tr><td>Oct 15, 2020 7:01:34 AM</td><td>3 ✓</td><td>4</td><td>Sour</td><td>4.4</td><td>3.2</td><td>2.1</td></tr></tbody></table>								Timestamp	Phase	Product #	Product Name	Oz	TimeEstimated	TimeActual	Oct 15, 2020 6:25:29 AM	1 ✓	1	Detergent	17.6	13.1	7.5	Oct 15, 2020 6:26:08 AM	1 ✓	2	Builder	52.8	38.2	25.8	Oct 15, 2020 6:40:35 AM	2 ✓	3	Chlorine	37.4	25.4	15.0	Oct 15, 2020 7:01:34 AM	3 ✓	4	Sour	4.4	3.2	2.1
Timestamp	Phase	Product #	Product Name	Oz	TimeEstimated	TimeActual																																				
Oct 15, 2020 6:25:29 AM	1 ✓	1	Detergent	17.6	13.1	7.5																																				
Oct 15, 2020 6:26:08 AM	1 ✓	2	Builder	52.8	38.2	25.8																																				
Oct 15, 2020 6:40:35 AM	2 ✓	3	Chlorine	37.4	25.4	15.0																																				
Oct 15, 2020 7:01:34 AM	3 ✓	4	Sour	4.4	3.2	2.1																																				
> 2344	1	White Linen	Oct 15, 2020 9:32:07 AM		01:03:17	02:30:32	1 2 3 4 5 6 7 8																																			

15.00 troubleshooting

15.01 Troubleshooting Basics

Confirm Correct Calibration and Formula Programming in Controller

When troubleshooting for no product on signal, always confirm calibration and formula amounts are correctly programmed in the Controller.

Confirm J1 and J2 Cable Integrity

Always ensure that all telco connectors (J1 and J2 Cables) are clean and corrosion free. Examine cables for cuts or kinks which can indicate broken wires. When in doubt, replace possibly defective cables.

Consider Product Run Order

Only one product may run at a time in flush mode. Multiple products that are triggered simultaneously will queue up. Based on this rule, all products triggered will run as long as the load Count Pump trigger is last. Sufficient time must be allowed between triggers to enable all triggered products to run. Failure to allow sufficient time between triggers could result in triggers for products being ignored.

Suggested Service Parts

It is advised to keep an inventory of the following new or “known good” service parts to use for substitution purposes when troubleshooting (or these components can be can “borrowed” from an adjacent dispensing system):

- Controller
- Pump Interface PCB
- Wiring Harness Plate Assembly
- J1 Cable
- Machine Interface (with J2 Cable)

15.02 Load Count or Product Run Errors

Some load count or product run errors can be avoided by ensuring that (1) each wash formula has a load Count Pump set to be the last product run within that formula and (2) the washer has completed the cycle and all dispense amounts are correct.

It is suggested to use the diagnostic capabilities of the Activity Log to reconstruct a recent history of machine or operator problems that may explain poor results, excessive costs, or both. Although it can only hold several days of activity data it has the details that may be necessary to determine why an issue is occurring.

Additional Data Logging Factors:

- The dispenser “formula cycle” begins upon the first product trigger and ends when the Count Pump dispenses its last programmed amount, or when the dispenser operation is interrupted.
- If an Installer Password is input while a formula is running, the formula is aborted, the load is recorded as an incomplete load and the formula must be restarted upon exiting the Installer Menus.
- Synchronization of the dispenser controller to washer cycles is critical. Ensure that the load Count Pump assignment is correct for all wash formulas to assist in maintaining this synchronization.
- The Cycle Timer will start on the first product trigger of a load. It will reset the controller and stop the current load if its duration setting occurs before the Count Pump is run. It is preferred to use a designated Count Pump to stop a load, instead of the Cycle Timer.

Load Counts Too Low:

If load counts seem low, confirm the number of times the Count Pump ran vs. other products in the formula to see if the washer trigger signal is inconsistent or if the machine operator may be short cycling the washer.

Load Counts Too High:

Confirm the number of times that the Count Pump ran by checking the washer trigger signal for the Count Pump.

15.00 troubleshooting (continued)

15.03 Troubleshooting Table

The most important first step in troubleshooting the dispensing system is to confirm the failure or symptom that was reported.

Problem	Cause	Solution
1. Dead, no display	a. No power at source.	• Restore Power.
	b. Tripped or defective circuit breaker.	• Reset, or replace, circuit breaker.
	c. Defective PI PCB, J1 Cable, or Controller.	• Substitute components, one at a time.
2. No products run on Prime or on signal	a. No contact closure at flush connector.	• Reconnect Flush Jumper (non-flush) or troubleshoot flush system flow switch.
	b. Products are not calibrated.	• Perform Product Calibration.
	c. Damaged J1 Cable.	• Replace J1 Cable.
	d. Defective PI PCB, J1 Cable, or Controller.	• Substitute components, one at a time.
3. Some (but not all) products do not run on Prime or on signal.	a. Loose solenoid or motor wire connection.	• Repair loose solenoid or motor wire connection.
	b. Products are not calibrated.	• Perform Product Calibration.
	c. Damaged J1 Cable.	• Replace J1 Cable.
	d. Defective PI PCB, J1 Cable, or Controller.	• Substitute components, one at a time.
4. One or more products do not run on signal, but all products prime OK.	a. Products are not calibrated.	• Perform Product Calibration.
	b. Delay time preventing product from running or placing product in queue.	• Reprogram product delay times as described in section 10.00 "Programming" on page 41.
	c. Washer not sending signal, or signal wire loose.	• Repair/reprogram washer, reconnect signal wire(s).
	d. Product Interlock is only allowing dispenser to recognize first signal for each product in a load.	• Reset Controller by turning power off, then on.
	e. Defective PI PCB, J1 Cable, or Controller.	• Substitute components, one at a time.
	f. No amount programmed for product.	• Check formula, confirm amount is programmed.
5. Loads are not being counted.	a. "Count Pump" not running at all.	• Troubleshoot per Problem 4 above.
	b. Count Pump's last amount not being triggered.	• Reprogram washer supply signals and/or controller formulas to ensure all Count Pump amounts run.

16.00 specifications

16.01 Controller Specifications

Category	Specification
Size	5.2" W x 4.50" H x 2.5" D (13.2 cm W x 11.4 cm H x 6.4 cm D)
Weight	0.65 lb. (0.30 kg)
Power Rating	SELV - Power source is dispenser.
System Capacity	99.99 oz. (2999 ml.) 8 product (with 3 amount settings per product) maximum
Data Input Field	15 characters maximum: (letters A-Z, numbers 0-9, hyphen [-], underscore [_] and space [])
Environmental Specifications	
IP, Pollution, Installation	IP Rating : 44 Pollution Category: 2 Installation Category: II
Operating Temperature	10° to 49° C (50° to 120° F) maximum
Operating Humidity	95% relative humidity, maximum
Operating Altitude	Install at or below 6.500 ft. (2000 M) maximum
Indoor Installation	Approved for indoor use only. Must not be installed outdoors.

Specifications subject to change without notice.

16.02 Gateway Specifications

Category	Specification
Size (Without ears)	5.06" W x 3.51" H x 1.61" D (12.85 cm W x 8.91 cm H x 4.1 cm D)
Weight	1.22 lb. (0.55 kg)
Power Ratings	Input Current 500 mA @ 12 VDC
	Input Voltage 9 to 36 VDC
	Power Consumption 6 W
Housing Material	Metal
Installation	DIN-rail mounting, Wall mounting (with optional kit)
Cellular Interface - US models	LTE Band 2 (1900 MHz) / LTE Band 4 (1700 MHz) / LTE Band 5 (850 MHz) / LTE Band 12 (700 MHz) / LTE Band 13 (700 MHz) / LTE Band 14 (700 MHz) / LTE Band 66 (1700 MHz) / LTE Band 71 (600 MHz)
	UMTS Bands: Band 2 (1900 MHz) / Band 4 (1700 MHz) / Band 5 (850 MHz)
	Carrier Approval: Verizon, AT&T
Cellular Interface - EU models	LTE Band 1 (2100 MHz) / LTE Band 3 (1800 MHz) / LTE Band 7 (2600 MHz) / LTE Band 8 (900 MHz) / LTE Band 20 (800 MHz) / LTE Band 28A (700 MHz)
	UMTS Bands: Band 1 (2100 MHz) / Band 3 (1800 MHz) / Band 8 (900 MHz)
Cellular Interface - AP models	LTE Band 1 (2100 MHz) / LTE Band 3 (1800 MHz) / LTE Band 5 (850 MHz) / LTE Band 8 (900 MHz) / LTE Band 9 (1700 MHz) / LTE Band 18 (850 MHz) / LTE Band 19 (850 MHz) / LTE Band 26 (850 MHz) / LTE Band 28 (700 MHz)
	UMTS Bands: Band 1 (2100 MHz) / Band 5 (850 MHz) / Band 6 (800 MHz) / Band 8 (900 MHz) / Band 19 (800 MHz)

17.00 warranty

17.01 Limited Warranty

Seller warrants solely to **Buyer** the Products will be free from defects in material and workmanship under normal use and service for a period of one year from the date of completion of manufacture. This limited warranty does not apply to (a) hoses; (b) and products that have a normal life shorter than one year; or (c) failure in performance or damage caused by chemicals, abrasive materials, corrosion, lightning, improper voltage supply, physical abuse, mishandling or misapplication. In the event the Products are altered or repaired by **Buyer** without **Seller's** prior written approval, all warranties will be void.

No other warranty, oral, express or implied, including any warranty of merchantability or fitness for any particular purpose, is made for these products, and all other warranties are hereby expressly excluded.

Seller's sole obligation under this warranty will be, at **Seller's** option, to repair or replace F.O.B. **Seller's** facility in Cincinnati, Ohio any Products found to be other than as warranted.

17.02 Limitation of Liability

Seller's warranty obligations and **Buyer's** remedies are solely and exclusively as stated herein. **Seller** shall have no other liability, direct or indirect, of any kind, including liability for special, incidental, or consequential damages or for any other claims for damage or loss resulting from any cause whatsoever, whether based on negligence, strict liability, breach of contract or breach of warranty.



Hydro Systems
3798 Round Bottom Road
Cincinnati, OH 45244

Phone 513.271.8800
Toll Free 800.543.7184
Fax 513.271.0160
Web hydrosystemsco.com

HYD10099890 Rev D 02/23